

01

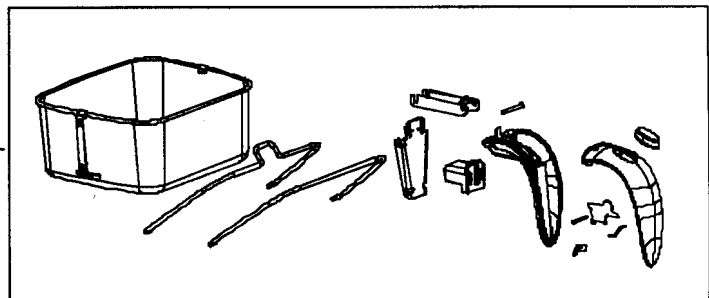

10

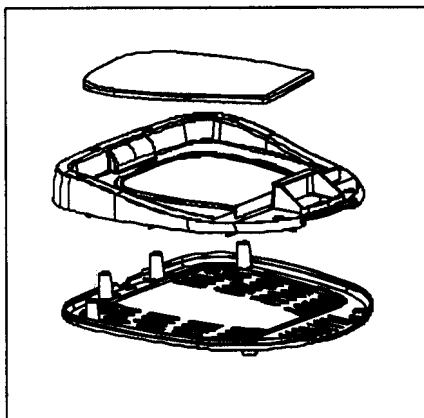

03

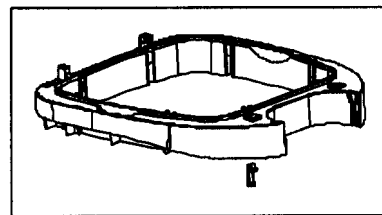

04

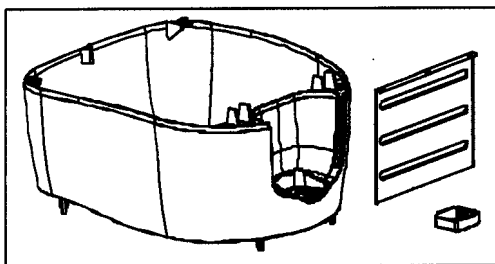

05



13

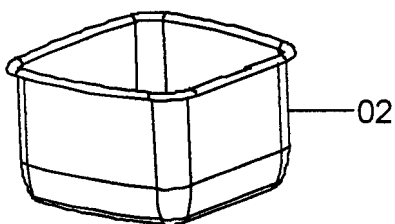
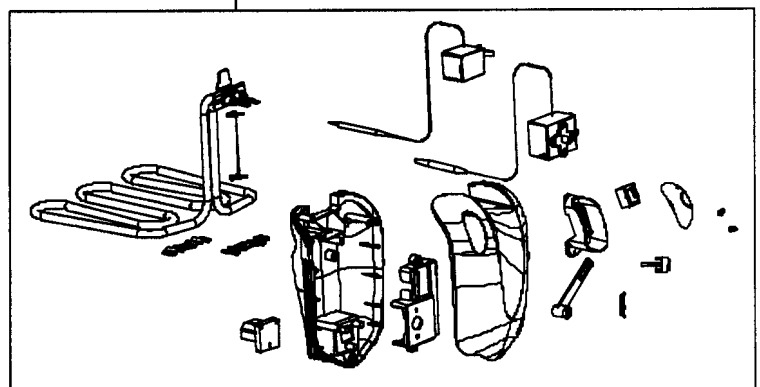

02

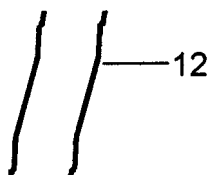

12



08



09

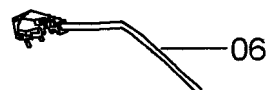

06

Position	Code	description
01	GO1000	COVER
02	GO1001	PAN
03	GO1002	SUPPORT BASE
04	GO1003	FRAME
05	GO1004	BODY ASSEMBLY
06	GO1005	POWER SUPPLY CORD
07	GO1006	PUSH BUTTON
08	GO1007	HOOK
09	GO1008	FOOT
10	ES000	*NOT AVAILABLE
11	GO1010	CONNECTOR
12	GO1011	WIRING
13	GO1015	HEATING Element ASSY