

**BARBECUES ELDORADO  
COMPACT - CLASSIC - PLUS -  
SUPER - DELUXE - EXPERT  
1998/99/2000/01**



**COMPACT**



**CLASSIC**



**PLUS**



**SUPER**



**DELUXE**



**EXPERT**

**BARBECUES ELDORADO  
COMPACT - CLASSIC - PLUS -  
SUPER - DELUXE - EXPERT  
1998/99/2000/01**

**JETS / INJECTEURS**

- 63558 (28 Mbar)
- 66340 (50 Mbar)

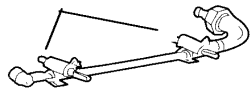
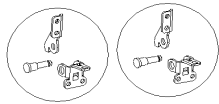

61503  
31871

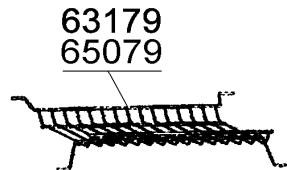
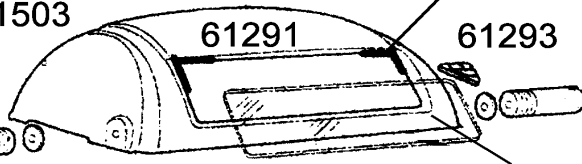

61294

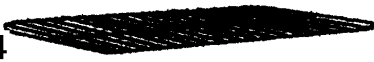

61295



- 61298
- 69210
- 70308

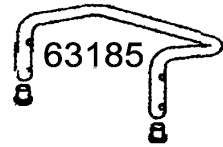
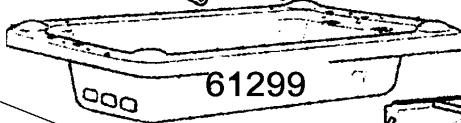
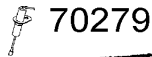

GAS PIPES - TUBULURES	
MOD. 2000/01 65064	MOD. 99 61308
MOD. 99/2000/01 61498 61499	

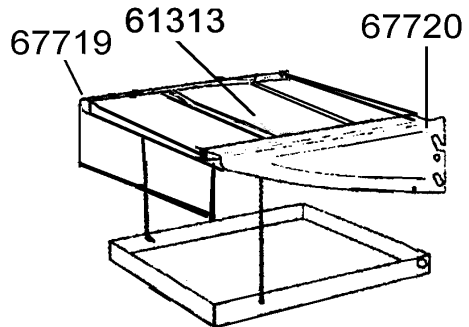

- 36948
- 61325

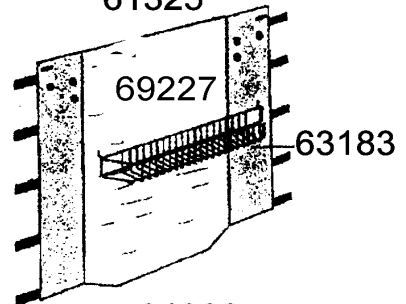

FOR SIDE STOVE,  
CF. SPECIFIC SCHEME  
POUR RECHAUD LATERAL,  
VOIR ECLATE SPECIFIQUE

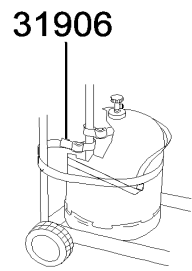
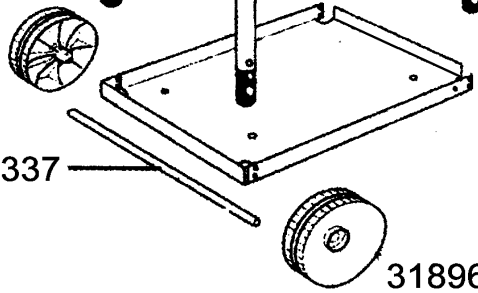



**BARBECUES ELDORADO  
COMPACT - CLASSIC - PLUS -  
SUPER - DELUXE - EXPERT  
1998/99/2000/01**

REF.	POINTS	GB - DESIGNATIONS	DESIGNATIONS - F -	COMPACT	CLASSIC	PLUS	SUPER	DELUXE	EXPERT
31834	30	FRONT PANEL KNOB (X2)	VOLANT DE CONSOLE (X2)	X	X	X	X	X	X
31871	80	HANDLE & (HANDLE GASKET)	POIGNEE+ (RONDELLE)	X	X	X	X	X	X
31896	50	WHEEL DIAMETER 150 (X 1)	ROUE DIAMETRE 150 (X 1)	X	X	X	X	X	X
31906	30	CYLINDER STRAP	SANGLE BOUTEILLE	X	X	X	X	X	X
36948	60	SIMPLE IGNITER	PIEZO SIMPLE	X	X	X	X		
40500	40	GREASE CAN + WIRE	BOITE A GRAISSE + FIL	X	X	X	X	X	X
61291	235	LID	COUVERCLE	X	X	X	X	X	X
61292	100	GLASS + (SUPPORT X4)	VITRE+ (EQUERRE X4)	X	X	X	X	X	X
61293	65	ANGULAR THERMOMETER	THERMOMETRE D'ANGLE				X	X	X
61294	120	NICKEL CHROME COOKING GRATE	GRILLE DE CUISSON CHROME	X	X	X	X	X	X
61295	90	LAVA ROCK GRATE	GRILLE PIERRE DE LAVE	X	X	X	X	X	X
61298	165	BURNER 28 MBAR	BRULEUR 28 MBAR	X	X	X	X	X	X
61299	295	BOTTOM	CUVE	X	X	X	X	X	X
61308	220	SIDE STOVE GAS PIPE 28MB 1/2"-M.99	TUBULURE RECHAUD LAT.28MB 1/2"-M.99					X	X
61313	80	SET OF 3 PLANKS	JEU DE 3 LATTES		X	X	X	X	
61325	83	DOUBLE IGNITOR	PIEZO DOUBLE					X	X
61327	70	GREY FOOT	PIED TOLE GRIS	X	X	X	X	X	X
61337	30	AXLE WHEEL	AXE DE ROUE	X	X	X	X	X	X
61498	150	GAS PIPE 28 MB- 1/2"	TUBULURE COMPLETE 28MB -1/2"	X	X	X	X		
61499	150	GAS PIPE 50 MB- 1/4"	TUBULURE COMPLETE 50MB-1/4"	X	X	X	X		
61503	50	LID HINGE SET (X 2)	CHARNIERES+AXE x 2 COUVERCLE	X	X	X	X	X	X
62231	60	GLASS SQUARE SUPPORT (X4)	EQUERRE VITRE (X4)	X	X	X	X	X	X
63179	120	ARTICULATED WARMING GRID MOD99	GRILLE MIJOTAGE ARTICULEE M99				X	X	X
63183	100	FRONTAL BASKET	PANIER FRONTAL				X	X	
63185	90	TUBE HANDLE COMPACT	POIGNEE TUBE COMPACT	X					
63558	30	JET	INJECTEUR	X	X	X	X	X	X
65064	260	SIDE STOVE GAS PIPE 28MB 1/2"	TUBULURE RECHAUD LATERAL 28MB 1/2"					X	X
65079	80	ARTICULATED WARMING GRID	GRILLE DE MIJOTAGE ARTICULEE				X	X	X
66340	30	JET	INJECTEUR	X	X	X	X	X	X
67719	60	LEFT SHELF HOLDER - GREY	SUPPORT ETAGERE GAUCHE - GRIS	X	X	X	X	X	X
67720	60	RIGHT SHELF HOLDER - GREY	SUPPORT ETAGERE DROIT - GRIS	X	X	X	X	X	X
67940	30	SCREW (X 5) FOR BURNER	VIS (x 5) POUR BRULEUR	X	X	X	X	X	X
69210	150	BURNER 50 MBAR	BRULEUR 50 MBAR	X	X	X	X	X	X
69227	110	CYLINDER COVER	JUPE	X	X	X	X	X	X
70279	50	ELECTRODE + HOLDER	ELECTRODE + CACHE ELECTRODE	X	X	X	X	X	X
70308	220	ACCESSORY BURNER ELDORADO/EXPERT	ACCESSOIRE BRULEUR ELDORADO/EXPERT	X	X	X	X	X	X
	<b>O</b>	<b>POUR RECHAUD LATERAL VOIR ECLATE RECHAUD ELDORADO FOR SIDE STOVE SEE SIDE STOVE SCHEME OF ELDORADO</b>						X	X