

**RANCHERO - TYPES 6000 - 9000 -  
11000 - 12000  
94-95-96**



61293

(FOR GLASS WITH INNER BRACKETS)  
(POUR VITRE AV.PATTES INTERIEURES)  
(FOR GLASS WITH SQUARE SUPPORTS)  
(POUR VITRE AV.EQUERRES)

FOR SIDE STOVE,  
CF. SPECIFIC SCHEME  
POUR RECHAUD LATERAL,  
VOIR ECLATE SPECIFIQUE

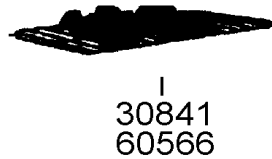
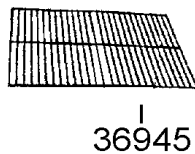
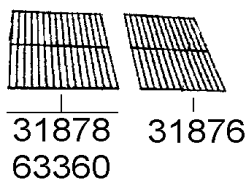
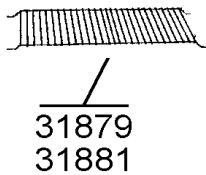
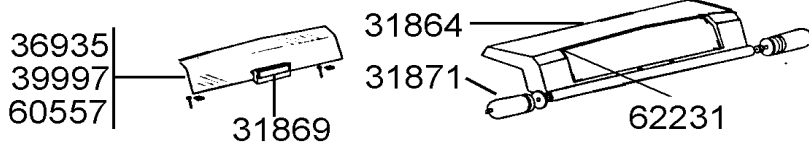

Jet / Injecteur ( 28 mb ) :  
31839  
31841  
63558

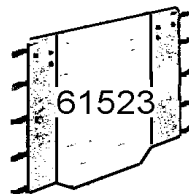
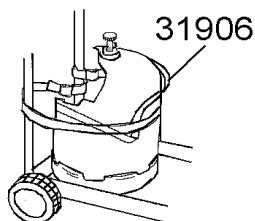
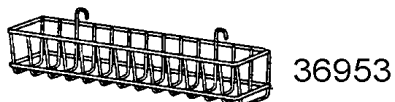
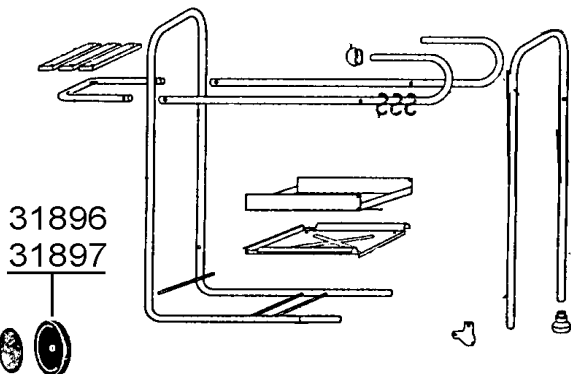
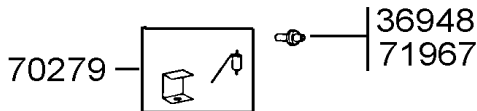
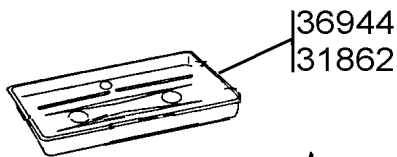
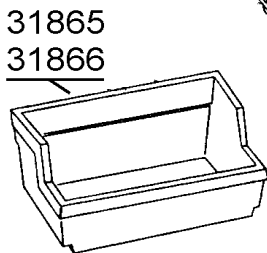
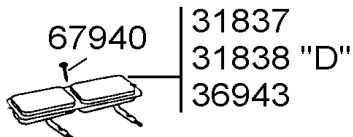

**RANCHERO 6000 - 6000 PLUS  
6000 PLUS 3 - 6000 S**



REF.	POINTS	- GB - DESIGNATIONS	DESIGNATIONS - F -	6000	6000 +	6000+ 3	6000 S
30841	120	LAVA ROCK GRID	GRILLE PIERRE DE LAVE	X	X	X	X
31834	30	FRONT PANEL KNOB (X2)	VOLANT DE CONSOLE (X2)	X	X	X	X
31871	80	HANDLE & (HANDLE GASKET)	POIGNEE+ (RONDELLE)	X	X	X	X
31896	50	WHEEL DIAMETER 150 (X 1)	ROUE DIAMETRE 150 (X 1)	X	X	X	X
36935	150	GLASS	VITRE	X	X	X	X
36943	160	COMPLETE BURNER & VENTURI	BRULEUR COMPLET + VENTURI	X	X	X	X
36944	225	BASE BOTTOM	FOND DE CUVE	X	X	X	X
36945	110	COOKING GRID	GRILLE DE CUISSON	X	X	X	X
36948	60	SIMPLE IGNITER	PIEZO SIMPLE	X	X	X	X
63558	30	JET	INJECTEUR	X	X	X	X
67940	30	SCREW (X 5) FOR BURNER	VIS (x 5) POUR BRULEUR	X	X	X	X
70279	50	ELECTRODE + HOLDER	ELECTRODE + CACHE ELECTRODE	X	X	X	X