

**RANCHERO - TYPES 6000 - 9000 -
11000 - 12000
94-95-96**



61293

(FOR GLASS WITH INNER BRACKETS)
(POUR VITRE AV.PATTES INTERIEURES)
(FOR GLASS WITH SQUARE SUPPORTS)
(POUR VITRE AV.EQUERRES)

FOR SIDE STOVE,
CF. SPECIFIC SCHEME
POUR RECHAUD LATERAL,
VOIR ECLATE SPECIFIQUE

36935
39997
60557

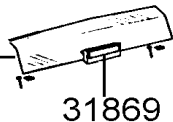

31869

31864

31871

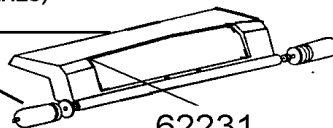

62231



31879
31881

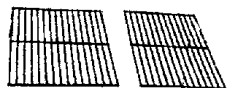

31878
63360

31876



36945



30841
60566

Jet / Injecteur (28 mb) :
31839
31841
63558

67940



31837
31838 "D"
36943

31865
31866

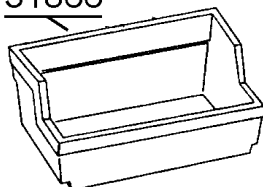

36944
31862



39532

70279

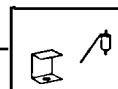

36948
71967

40500



31834
31849

31896
31897

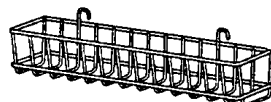
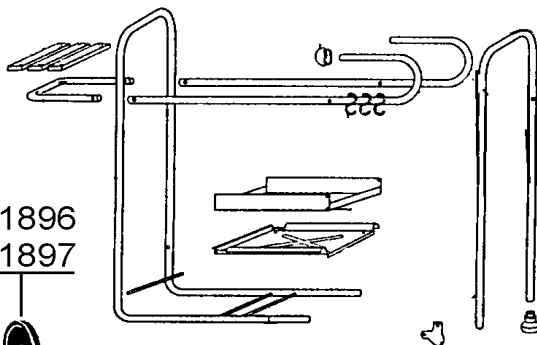

36953

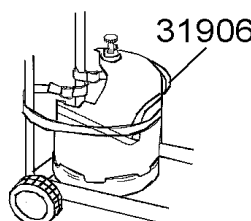

31906

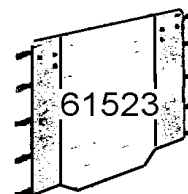

61523

**RANCHERO 6000 - 6000 PLUS
6000 PLUS 3 - 6000 S**



REF.	POINTS	- GB - DESIGNATIONS	DESIGNATIONS - F -	6000	6000 +	6000+ 3	6000 S
30841	120	LAVA ROCK GRID	GRILLE PIERRE DE LAVE	X	X	X	X
31834	30	FRONT PANEL KNOB (X2)	VOLANT DE CONSOLE (X2)	X	X	X	X
31871	80	HANDLE & (HANDLE GASKET)	POIGNEE+ (RONDELLE)	X	X	X	X
31896	50	WHEEL DIAMETER 150 (X 1)	ROUE DIAMETRE 150 (X 1)	X	X	X	X
36935	150	GLASS	VITRE	X	X	X	X
36943	160	COMPLETE BURNER & VENTURI	BRULEUR COMPLET + VENTURI	X	X	X	X
36944	225	BASE BOTTOM	FOND DE CUVE	X	X	X	X
36945	110	COOKING GRID	GRILLE DE CUISSON	X	X	X	X
36948	60	SIMPLE IGNITER	PIEZO SIMPLE	X	X	X	X
63558	30	JET	INJECTEUR	X	X	X	X
67940	30	SCREW (X 5) FOR BURNER	VIS (x 5) POUR BRULEUR	X	X	X	X
70279	50	ELECTRODE + HOLDER	ELECTRODE + CACHE ELECTRODE	X	X	X	X