

**RANCHERO - TYPES 6000 - 9000 -
11000 - 12000
94-95-96**



61293
(FOR GLASS WITH INNER BRACKETS)
(POUR VITRE AV.PATTES INTERIEURES)
(FOR GLASS WITH SQUARE SUPPORTS)
(POUR VITRE AV.EQUERRES)

FOR SIDE STOVE,
CF. SPECIFIC SCHEME
POUR RECHAUD LATERAL,
VOIR ECLATE SPECIFIQUE

36935
39997
60557

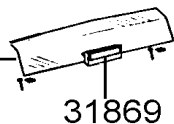

31869

31864
31871

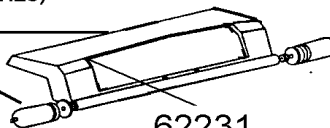

62231

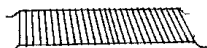

31879
31881

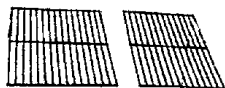

31878 31876
63360

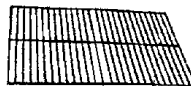

36945



30841
60566

Jet / Injecteur (28 mb) :

31839
31841
63558

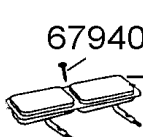

67940

31837
31838 "D"
36943

31865
31866

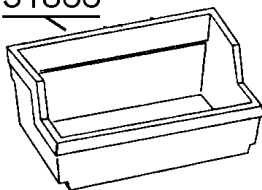

36944
31862



39532

70279

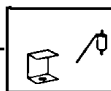

36948
71967



40500



31834
31849

31896
31897

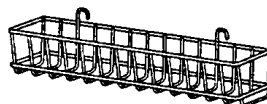
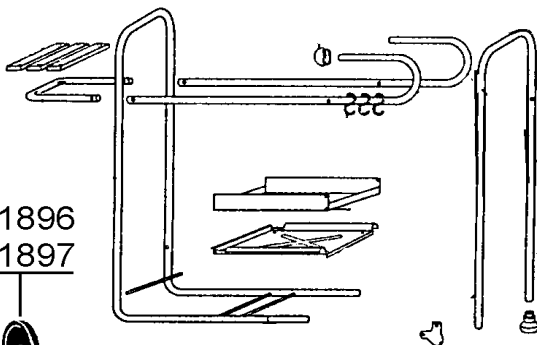

36953

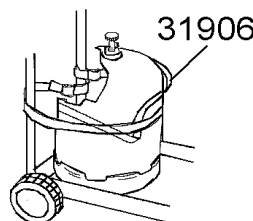

31906

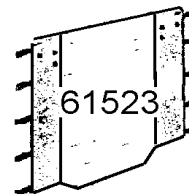

61523

**RANCHERO 9000 CLASSIC -
SPECIAL - PLUS - SUPER - S -**



9000 SUPER

REF.	POINTS	- GB - DESIGNATIONS	DESIGNATIONS - F -	CLASSIC	CLASSIC 2-3	SPECIAL	SPECIAL 2	PLUS	PLUS 2-3	SUPER	SUPER 2-3 & S
31834	30	FRONT PANEL KNOB (X2)	VOLANT DE CONSOLE (X2)	X	X	X	X	X	X	X	X
31837	165	BURNER	BRULEUR	X	X	X	X	X	X	X	X
31838	135	BURNER TYPE "D"	BRULEUR "ALLEMAND"	X	X	X	X	X	X	X	X
31839	30	JET	INJECTEUR	X	X	X	X	X	X	X	X
31849	320	CONTROL PANEL	CONSOLE	X	X	X	X	X	X	X	X
31862	150	BASE BOTTOM	FOND DE CUVE	X	X	X	X	X	X	X	X
31865	650	BASE	CUVE	X	X	X	X	X	X	X	X
31869	80	RECTANGULAR THERMOMETER	THERMOMETRE RECTANGULAIRE	X	X	X	X	X	X	X	X
31871	80	HANDLE & (HANDLE GASKET)	POIGNEE+ (RONDELLE)	X	X	X	X	X	X	X	X
31879	120	CHROMED WARMING GRID	GRILLE DE MIJOTAGE CHROMEE			X	X			X	X
31896	50	WHEEL DIAMETER 150 (X 1)	ROUE DIAMETRE 150 (X 1)	X	X						
31897	50	WHEEL DIAMETER 175 (X 1)	ROUE DIAMETRE 175 (X 1)					X	X	X	X
31906	30	CYLINDER STRAP	SANGLE BOUTEILLE					X	X	X	X
36948	60	SIMPLE IGNITER	PIEZO SIMPLE		X		X		X		X
36953	100	FRONT BASKET	PANIER FRONTAL						X		X
39532	220	COMPLETE GAS PIPE-28 MBAR 1/2"	TUBULURE COMPLETE-28 MBAR 1/2"	X	X	X	X	X	X	X	X
40500	40	GREASE CAN + WIRE	BOITE A GRAISSE + FIL	X	X	X	X	X	X	X	X
60557	150	GLASS +(SUPPORT X4)	VITRE + (EQUERRE X4)	X	X	X	X	X	X	X	X
60566	90	LAVA ROCK GRATE	GRILLE PIERRE DE LAVE	X	X	X	X	X	X	X	X
61293	65	ANGULAR THERMOMETER	THERMOMETRE D'ANGLE	X	X	X	X	X	X	X	X
61523	120	FRONT COVER (GREY/YELLOW)	JUPE TEXTILE (GRISE/JAUNE)	X	X	X	X	X	X	X	X
62231	60	GLASS SQUARE SUPPORT (X4)	EQUERRE VITRE (X4)	X	X	X	X	X	X	X	X
63360	80	HALF COOKING CHROMED GRID	DEMI GRILLE CUISSON CHROMEE	X	X	X	X	X	X	X	X
67940	30	SCREW (X 5) FOR BURNER	VIS (x 5) POUR BRULEUR	X	X	X	X	X	X	X	X
70279	50	ELECTRODE + HOLDER	ELECTRODE + CACHE ELECTRODE	X	X	X	X	X	X	X	X
71967	85	PIEZO (+ NUT)	PIEZO (+ ECROU)	X		X		X		X	