

**RANCHERO - TYPES 6000 - 9000 -
11000 - 12000
94-95-96**



61293
(FOR GLASS WITH INNER BRACKETS)
(POUR VITRE AV.PATTES INTERIEURES)
(FOR GLASS WITH SQUARE SUPPORTS)
(POUR VITRE AV.EQUERRES)

FOR SIDE STOVE,
CF. SPECIFIC SCHEME
POUR RECHAUD LATERAL,
VOIR ECLATE SPECIFIQUE

36935
39997
60557

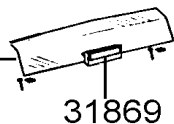

31869

31864
31871

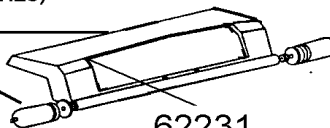

62231

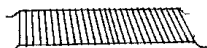

31879
31881

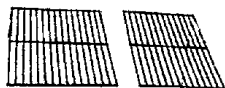

31878 31876
63360

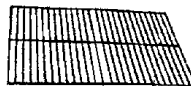

36945



30841
60566

Jet / Injecteur (28 mb) :

31839
31841
63558

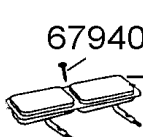

67940 | 31837
31838 "D"
36943

31865
31866

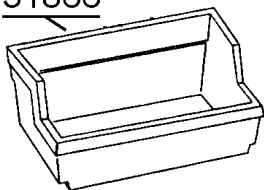

36944
31862



39532

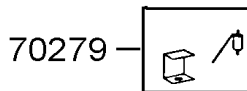

70279

36948
71967



40500

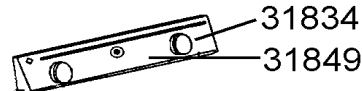

31834
31849

31896
31897

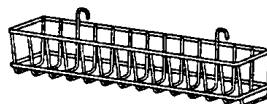
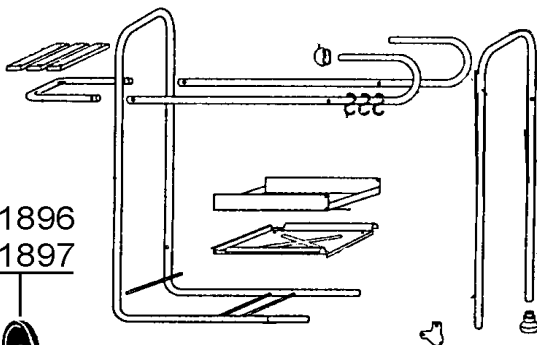

36953

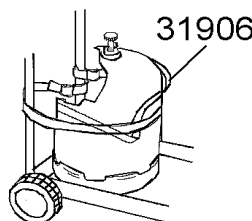

31906

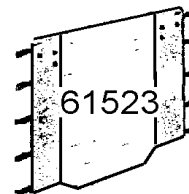

61523

**RANCHERO 9000 CLASSIC -
SPECIAL - PLUS - SUPER - S -**



9000 SUPER

| REF. | POINTS | - GB - DESIGNATIONS | DESIGNATIONS - F - | CLASSIC | CLASSIC 2-3 | SPECIAL | SPECIAL 2 | PLUS | PLUS 2-3 | SUPER | SUPER 2-3 & S |
|-------|--------|--------------------------------|--------------------------------|---------|-------------|---------|-----------|------|----------|-------|---------------|
| 31834 | 30 | FRONT PANEL KNOB (X2) | VOLANT DE CONSOLE (X2) | X | X | X | X | X | X | X | X |
| 31837 | 165 | BURNER | BRULEUR | X | X | X | X | X | X | X | X |
| 31838 | 135 | BURNER TYPE "D" | BRULEUR "ALLEMAND" | X | X | X | X | X | X | X | X |
| 31839 | 30 | JET | INJECTEUR | X | X | X | X | X | X | X | X |
| 31849 | 320 | CONTROL PANEL | CONSOLE | X | X | X | X | X | X | X | X |
| 31862 | 150 | BASE BOTTOM | FOND DE CUVE | X | X | X | X | X | X | X | X |
| 31865 | 650 | BASE | CUVE | X | X | X | X | X | X | X | X |
| 31869 | 80 | RECTANGULAR THERMOMETER | THERMOMETRE RECTANGULAIRE | X | X | X | X | X | X | X | X |
| 31871 | 80 | HANDLE & (HANDLE GASKET) | POIGNEE+ (RONDELLE) | X | X | X | X | X | X | X | X |
| 31879 | 120 | CHROMED WARMING GRID | GRILLE DE MIJOTAGE CHROMEE | | | X | X | | | X | X |
| 31896 | 50 | WHEEL DIAMETER 150 (X 1) | ROUE DIAMETRE 150 (X 1) | X | X | | | | | | |
| 31897 | 50 | WHEEL DIAMETER 175 (X 1) | ROUE DIAMETRE 175 (X 1) | | | | | X | X | X | X |
| 31906 | 30 | CYLINDER STRAP | SANGLE BOUTEILLE | | | | | X | X | X | X |
| 36948 | 60 | SIMPLE IGNITER | PIEZO SIMPLE | | X | | X | | X | | X |
| 36953 | 100 | FRONT BASKET | PANIER FRONTAL | | | | | | X | | X |
| 39532 | 220 | COMPLETE GAS PIPE-28 MBAR 1/2" | TUBULURE COMPLETE-28 MBAR 1/2" | X | X | X | X | X | X | X | X |
| 40500 | 40 | GREASE CAN + WIRE | BOITE A GRAISSE + FIL | X | X | X | X | X | X | X | X |
| 60557 | 150 | GLASS +(SUPPORT X4) | VITRE + (EQUERRE X4) | X | X | X | X | X | X | X | X |
| 60566 | 90 | LAVA ROCK GRATE | GRILLE PIERRE DE LAVE | X | X | X | X | X | X | X | X |
| 61293 | 65 | ANGULAR THERMOMETER | THERMOMETRE D'ANGLE | X | X | X | X | X | X | X | X |
| 61523 | 120 | FRONT COVER (GREY/YELLOW) | JUPE TEXTILE (GRISE/JAUNE) | X | X | X | X | X | X | X | X |
| 62231 | 60 | GLASS SQUARE SUPPORT (X4) | EQUERRE VITRE (X4) | X | X | X | X | X | X | X | X |
| 63360 | 80 | HALF COOKING CHROMED GRID | DEMI GRILLE CUISSON CHROMEE | X | X | X | X | X | X | X | X |
| 67940 | 30 | SCREW (X 5) FOR BURNER | VIS (x 5) POUR BRULEUR | X | X | X | X | X | X | X | X |
| 70279 | 50 | ELECTRODE + HOLDER | ELECTRODE + CACHE ELECTRODE | X | X | X | X | X | X | X | X |
| 71967 | 85 | PIEZO (+ NUT) | PIEZO (+ ECROU) | X | | X | | X | | X | |