

SCB25CE

SCB36CE

SCB47CE

SCB60CE

SCB72CE

SCB84CE

Super Charbroiler

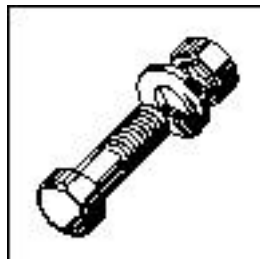

Spare Parts



SCB25CE
 SCB36CE
 SCB47CE
 SCB60CE
 SCB72CE
 SCB84CE

INDEX

The Wolf Super Char-Broiler has specially designed grates with a cast-in grease trough, steel reflector baffle that creates a cool zone in the grease drawer and drip tray area.

4 models to choose from with 4, 6, 8 or 10 burners, each individually controlled. The burners are rated at 14,500 Btu input for high and immediate heat power.

Description	Page
Technical Specification	3 - 4
Burner Assembly	5 - 6
Gas Valve & Regulator	7 - 8
Pilot Assembly	9 - 10
Drip Trays / Panels / Adj-Feet & Brushes	11 - 12
Stands / Tables (Accessories)	13



Technical Specification

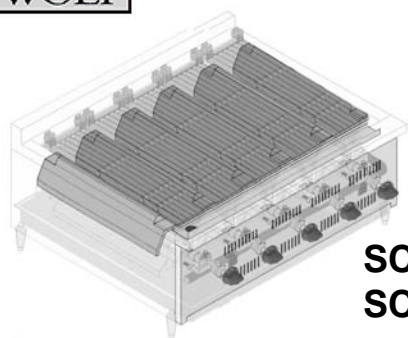

SCB25CE-1 (Natural Gas)
SCB25CE-2 (L.P. Gas)

Width 641mm / Depth 695mm / Height 375mm
Burners 4
17.0kW
Btu Rating 58,000
Shipping Weight = 115 kg

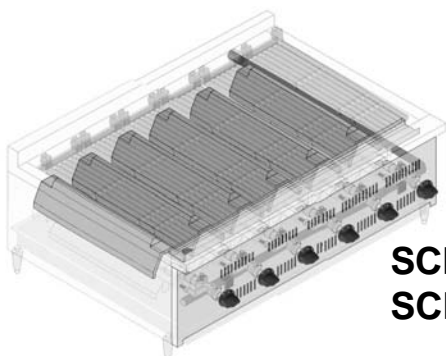

SCB36CE-1 (Natural Gas)
SCB36CE-2 (L.P. Gas)

Width 915mm / Depth 695mm / Height 375mm
Burners 6
25.6kW
Btu Rating 87,000
Shipping Weight =161 kg

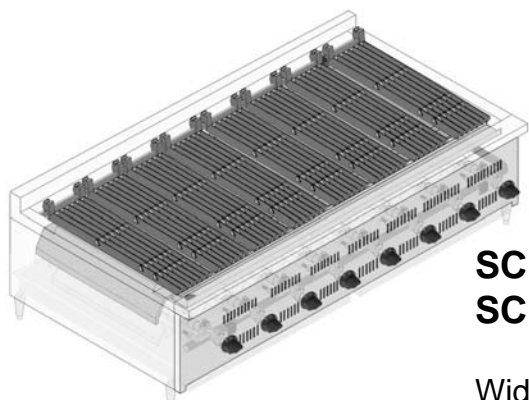

SCB47CE-1 (Natural Gas)
SCB47CE-2 (L.P. Gas)

Width 1188mm / Depth 695mm / Height 375mm
Burners 8
34.0kW
Btu Rating 116,000
Shipping Weight =230 kg



Technical Specification

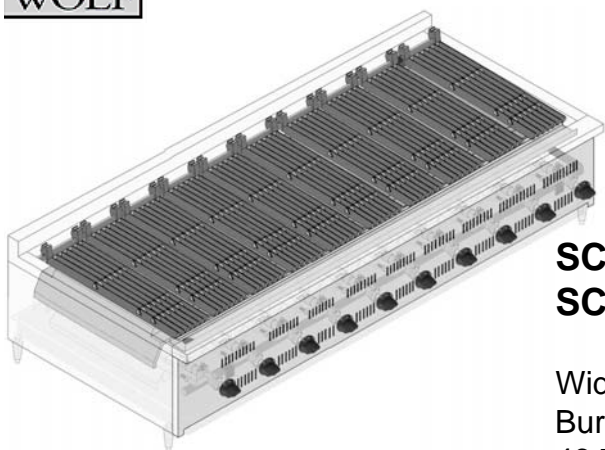

SCB60CE-1 (Natural Gas)
SCB60CE-2 (L.P. Gas)

Width 1520mm / Depth 695mm / Height 375mm
Burners 11
46.7kW
Btu Rating 159,000
Shipping Weight =360 kg

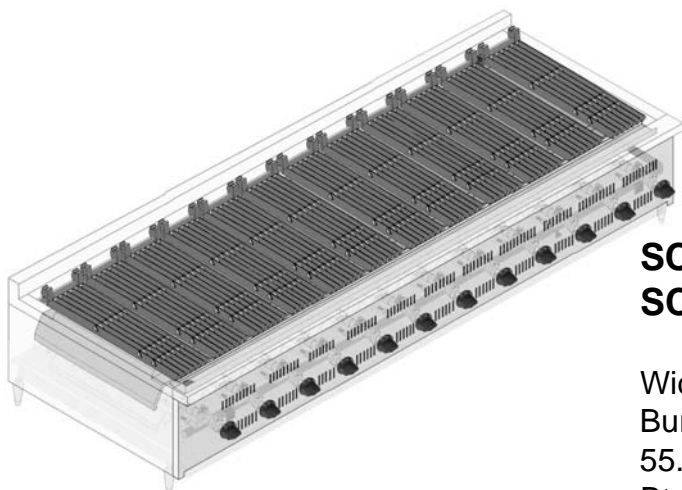

SCB72CE-1 (Natural Gas)
SCB72CE-2 (L.P. Gas)

Width 1829mm / Depth 695mm / Height 375mm
Burners 13
55.2kW
Btu Rating 188,500
Shipping Weight =430 kg

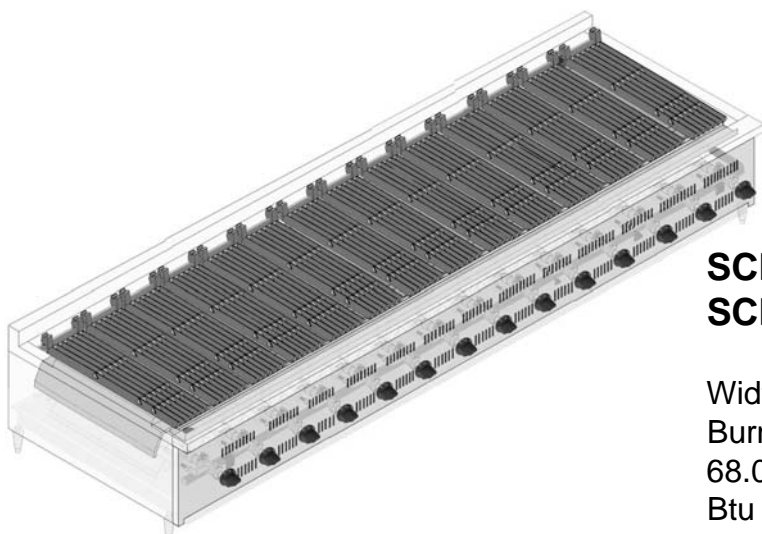

SCB84CE-1 (Natural Gas)
SCB84CE-2 (L.P. Gas)

Width 2134mm / Depth 695mm / Height 375mm
Burners 16
68.0kW
Btu Rating 232,000
Shipping Weight =500 kg



Burner Assembly

SCB25CE
SCB36CE
SCB47CE
SCB60CE
SCB72CE
SCB84CE

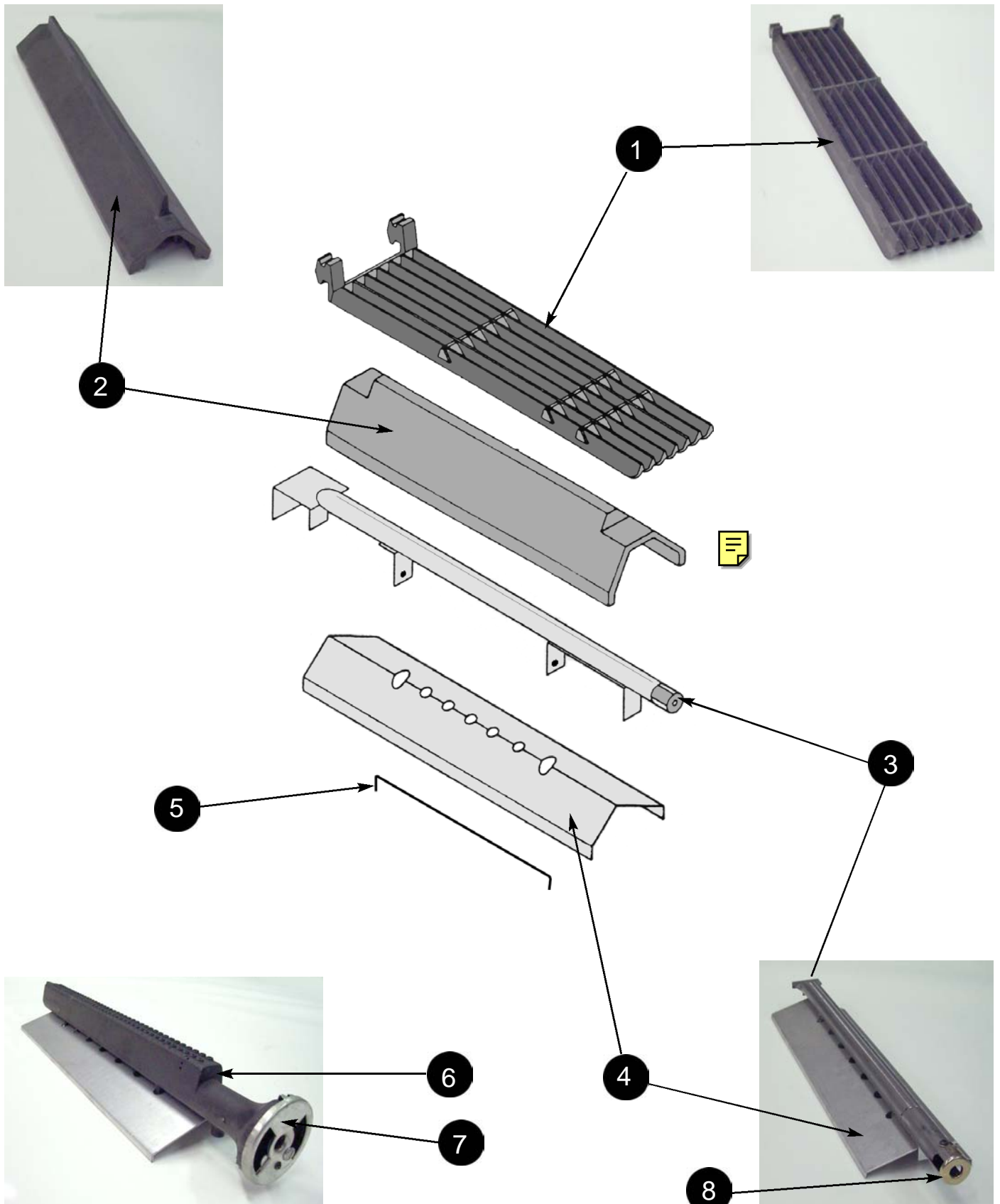



Burner Assembly

SCB25CE
SCB36CE
SCB47CE
SCB60CE
SCB72CE
SCB84CE

Key No	Part No	Description
1	710424	Grate - Slanted 7 rung
	710423	Grate - Straight
	722131	Grate- Slanted 6 rung, end grate
2	710407	Radiant
3	710453	Burner - S/Steel - NAT. GAS 520mm long
4	700416	Heat Deflector - Burner
5	710455	Rod - Deflector
6	700871A	Burner Assy - Cast Iron - L.P.G
7	719329	Air Shutter - L.P.G
8	719662	Air Shutter - NAT. GAS



Gas Valve & Regulator

SCB25CE
SCB36CE
SCB47CE
SCB60CE
SCB72CE
SCB84CE

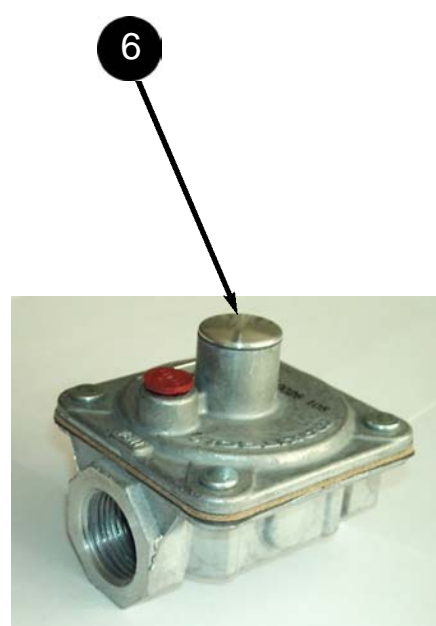
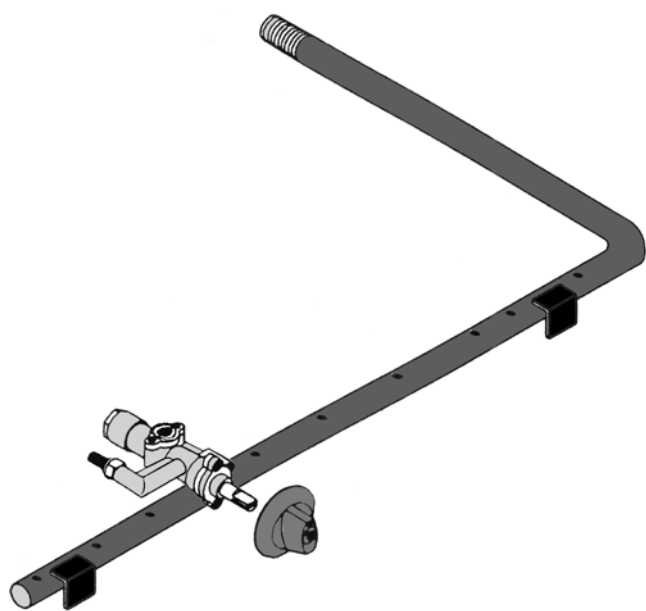
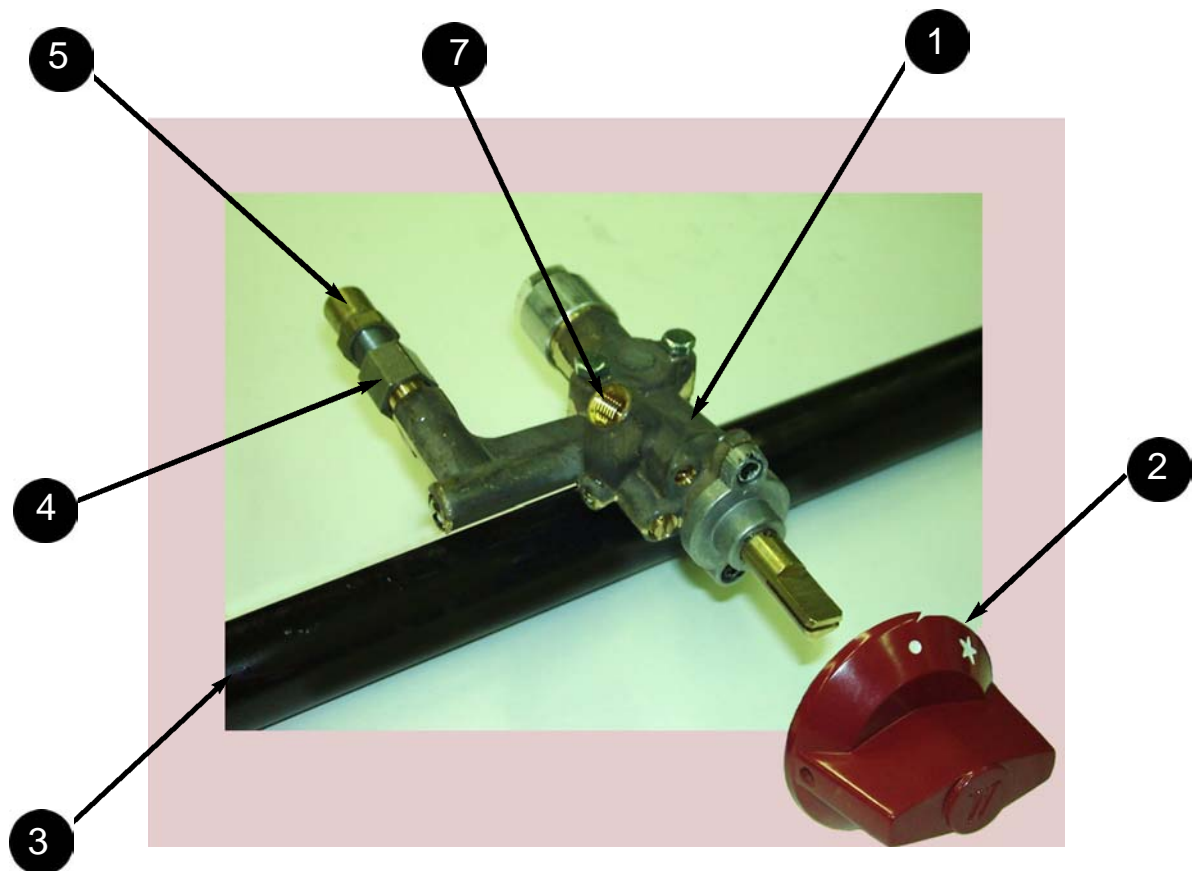



Gas Valve & Regulator

SCB25CE
 SCB36CE
 SCB47CE
 SCB60CE
 SCB72CE
 SCB84CE

Key No	Part No	Description
1	720516-4 SP-E-1-7	Gas Valve - Left Hand Magnet unit ,gas valve
2	719255-3	Knob - Gas Valve (C/W grub screw)
3	722446 722448 722449 722450 722451 722452	Manifold Pipe with Angle Bracket - SCB25CE Manifold Pipe with Angle Bracket - SCB36CE Manifold Pipe with Angle Bracket - SCB47CE Manifold Pipe with Angle Bracket - SCB60CE Manifold Pipe with Angle Bracket - SCB72CE Manifold Pipe with Angle Bracket - SCB84CE
4	719192	Adaptor - Orifice Extention
5	719951-51 719951-57	Injector - NAT. GAS Injector - L.P.G.
6	720722 720723	Regulator - NAT. GAS Regulator - L.P.G
7	720888 720889	Nut - Pilot Tube 3/16 M8 Fitting (not shown on drawing, fit item 1) Olive - Pilot Tube (not shown on drawing , fit item 1)



Pilot Assembly

DRAFT COPY

SCB25CE
SCB36CE
SCB47CE
SCB60CE
SCB72CE
SCB84CE

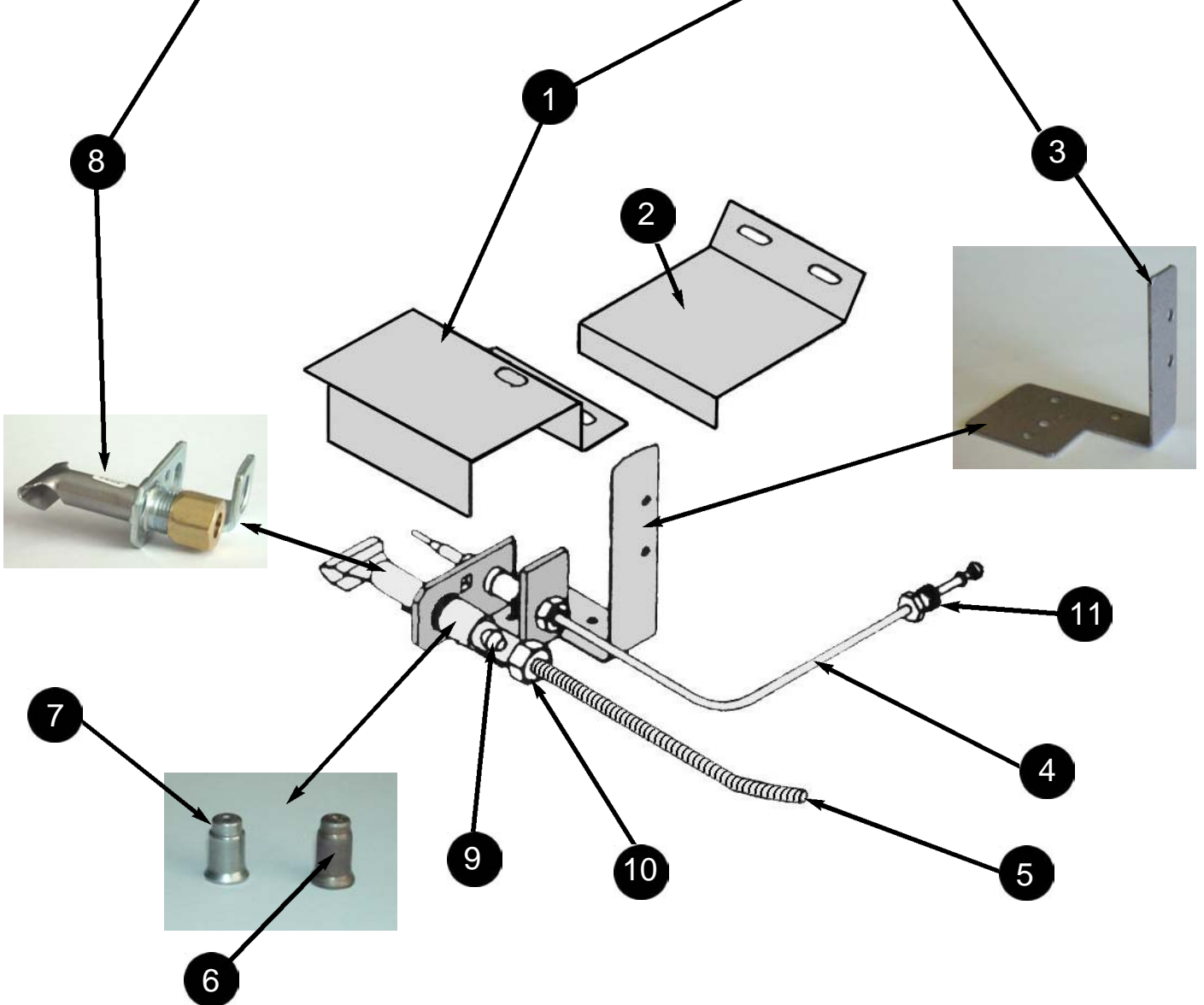
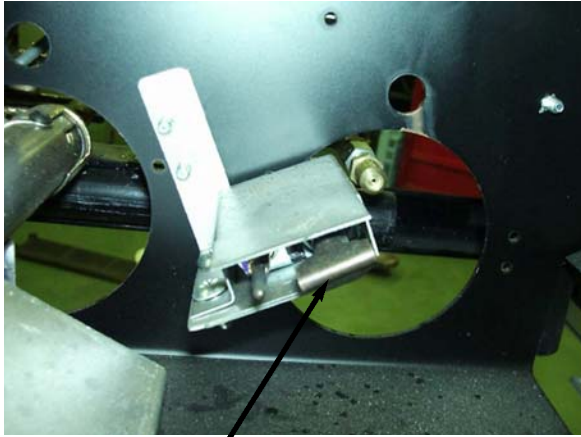



Pilot Assembly

SCB25CE
 SCB36CE
 SCB47CE
 SCB60CE
 SCB72CE
 SCB84CE

Key No	Part No	Description
1	769805	Shield - Thermocouple
2	769806	Shield - Thermocouple (For End Burners)
3	769961	Bracket - Pilot
4	GE-E-1-37	Thermocouple - Long Life - 320mm NOTE: If you have an earlier style Thermocouple you will need to up-grade to a Long Life (as above).
5	723378	3/16 Flex Tubing 6"
	723379	3/16 Flex Tubing 12"
	723380	3/16 Flex Tubing 18"
	723381	3/16 Flex Tubing 24"
	723382	3/16 Flex Tubing 30"
	723383	3/16 Flex Tubing 36"
	723384	3/16 Flex Tubing 42"
	723385	3/16 Flex Tubing 48"
6	711339-P	Pilot Injector - L.P.G - 1.0P
7	711339-N	Pilot Injector - NAT GAS - 1.8N
8	714269	Pilot Burner (Items 9 and 10 must also be ordered with this part.)
9	714200	Ferrule - Pilot
10	722466	Nut - Pilot
11	GE-E-1-36	M8 Split Nut (STD) OR
	GE-E-1-38	Magnet Unit M9
	GE-E-1-39	Split Nut M9



Drip Trays / Panels / Adj-Feet & Brushes

D

SCB25CE
SCB36CE
SCB47CE
SCB60CE
SCB72CE
SCB84CE

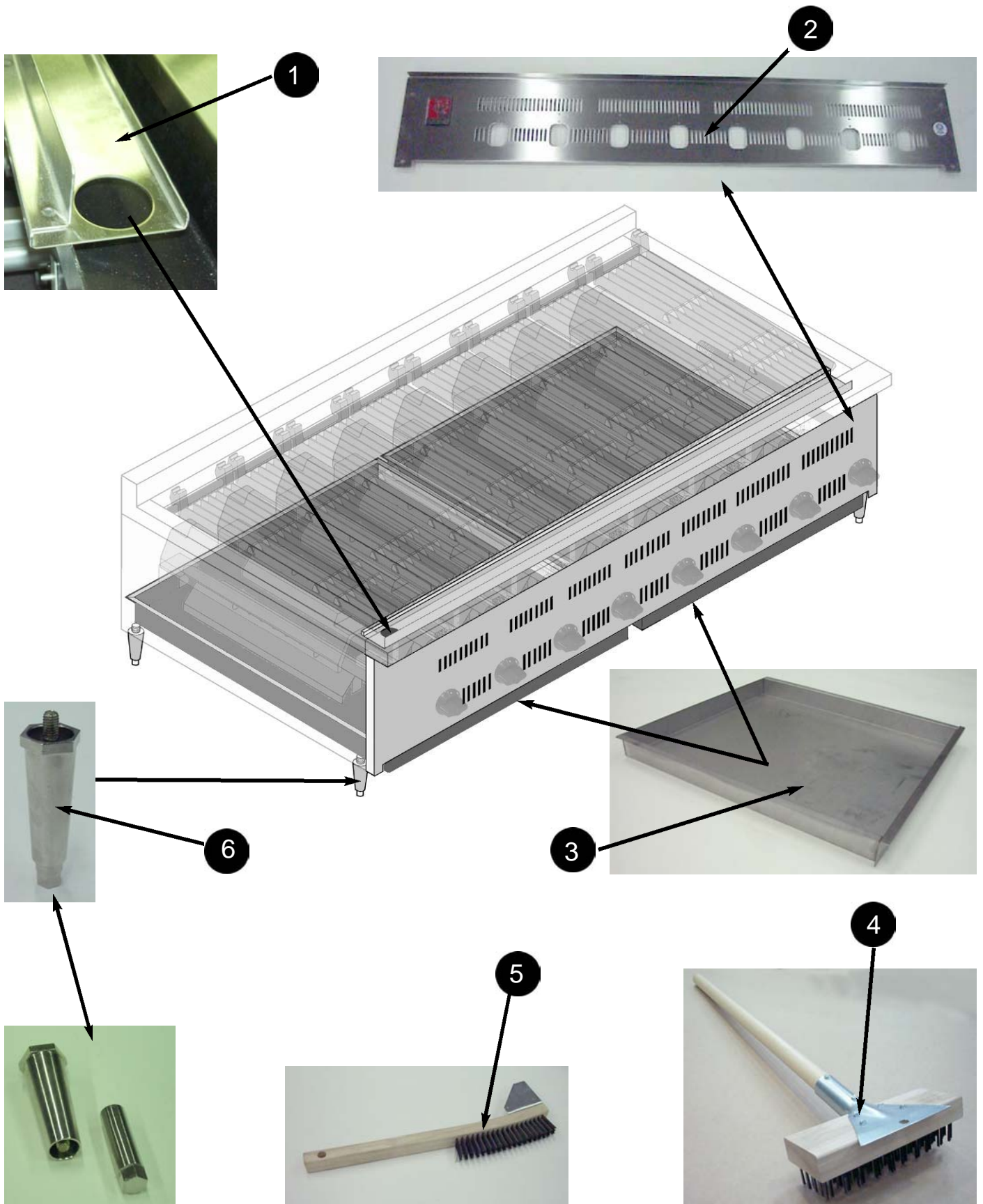



Drip Trays / Panels / Adj-Feet & Brushes

SCB25CE
 SCB36CE
 SCB47CE
 SCB60CE
 SCB72CE
 SCB84CE

Key No	Part No	Description
1	700868-A	Grease Insert Channel - SCB25CE
	700894-A	Grease Insert Channel - SCB36CE
	700917-A	Grease Insert Channel - SCB47CE
	700986-A	Grease Insert Channel - SCB60CE
	701163-A	Grease Insert Channel - SCB72CE
	???????	Grease Insert Channel - SCB84CE
2	768479	Front Panel - SCB25CE
	768481	Front Panel - SCB36CE
	768482	Front Panel - SCB47CE
	766172	Front Panel - SCB60CE
	766173	Front Panel - SCB72CE
	766174	Front Panel - SCB84CE
3	765335-A	Drip Tray - SCB25CE x 1
	765334-A	Drip Tray - SCB36CE x 1
	765335-A	Drip Tray - SCB47CE x 2
	765334-A	Drip Tray - SCB60CE x 2
	765337-A	Drip Tray - SCB72CE x 2
	765338-A	Drip Tray - SCB84CE x 2
4	720432	Cleaning Brush - De-Lox Course - STD - Bass
	720431	Cleaning Brush - Fine
5	710412	Cleaning Brush (supplied with machine)
6	719260	Adjustable Feet - 4"
	715132	Castor-Brake 5"
	715131	Castor-non Brake 5"



Accessories

Stands / Tables

SCB25CE
 SCB36CE
 SCB47CE
 SCB60CE
 SCB72CE
 SCB84CE

Part No	Description
ML-109150	610mm Wide Mobile Table
ML-109151	610mm Wide Static Table + Adj Feet
ML-109152	914mm Wide Mobile Table
ML-109153	914mm Wide Static Table + Adj Feet
ML-109154	1220mm Wide Mobile Table
ML-109155	1220mm Wide Static Table + Adj Feet
ML-109156	1524mm Wide Mobile Table
ML-109157	1524mm Wide Static Table + Adj Feet
ML-109158	1829mm Wide Mobile Table
ML-109159	1829mm Wide Static Table + Adj Feet

DRAFT ONLY

SCB'S NEW PARTS

10/10/03 / Steve Farajian

PART#	DESCRIPTION	MODEL / QTY
769962-1	Bracket LH, Front Panel Extension	All / 1
769963-1	Bracket RH, Front Panel Extension	All / 1
756356A3	CENTER DRIP PAN GUIDE	SCB47, 60, 72, 84, 96 / 1
764578-3A	FRONT ANGLE BAR	SCB25 / 1
764579-3A	FRONT ANGLE BAR	SCB30 / 1
764580-3A	FRONT ANGLE BAR	SCB36 / 1
764 581-3A	FRONT ANGLE BAR	SCB47 / 1
764582-3A	FRONT ANGLE BAR	SCB60 / 1
764583-3A	FRONT ANGLE BAR	SCB72 / 1
764584-3A	FRONT ANGLE BAR	SCB84 / 1
764598-3A	FRONT ANGLE BAR	SCB96 / 1
788133-1	BAFFLE, HEAT DEFLECTOR	SCB25 / 1
788134-1	BAFFLE, HEAT DEFLECTOR	SCB30 / 1
788126-1	BAFFLE, HEAT DEFLECTOR	SCB36 / 1
788135-1	BAFFLE, HEAT DEFLECTOR	SCB47 / 1
788136-1	BAFFLE, HEAT DEFLECTOR	SCB60 / 1
788137-1	BAFFLE, HEAT DEFLECTOR	SCB72 / 1
788138-1	BAFFLE, HEAT DEFLECTOR	SCB84 / 1
788139-1	BAFFLE, HEAT DEFLECTOR	SCB96 / 1
700475-3	TOP FRONT FRAME	SCB25 / 1
700474-3	TOP FRONT FRAME	SCB30 / 1
700473-3	TOP FRONT FRAME	SCB36 / 1
700471-3	TOP FRONT FRAME	SCB47 / 1
700836-3	TOP FRONT FRAME	SCB60 / 1
700803-3	TOP FRONT FRAME	SCB72 / 1
701245-3	TOP FRONT FRAME	SCB84 / 1
758344-3	TOP FRONT FRAME	SCB96 / 1
719192	ADAPTER,VALVE-1/2HX-3/8-27	SCB25, 30, 36, 47, 60, 72, 84, 96 / 4, 5, 6, 8, 10, 12, 14, 16
710453-1	BURNER SST, VC SERIES 590mm long	SCB25, 30, 36, 47, 60, 72, 84, 96 / 4, 5, 6, 8, 10, 12, 14, 16
723400-1	THERMOCOUPLE, 320MM	SCB25, 30, 36, 47, 60, 72, 84, 96 / 4, 5, 6, 8, 10, 12, 14, 16
723379	TUBING (PILOT) ,FLEX 3/16- 12"	SCB25, 30, 36, 47, 60, 72, 84, 96 / 4, 5, 6, 8, 10, 12, 14, 16

EXISTING PARTS

720516-1
766178A

VALVE, LH
PILOT ASSEMBLY

SCB25, 30, 36, 47, 60, 72, 84, 96 / 4, 5, 6, 8, 10, 12, 14, 16
SCB25, 30, 36, 47, 60, 72, 84, 96 / 4, 5, 6, 8, 10, 12, 14, 16

DRAFT ONLY



As continued product improvement is a policy of WOLF, specifications are subject to change without notice.