







# Evolution (D)

-  Manuale installazione e uso
-  User and installation manual
-  Installations- und Gebrauchshandbuch
-  Manuel d'installation et d'emploi
-  Manual de instalación y uso
-  Руководство по эксплуатации и техобслуживанию

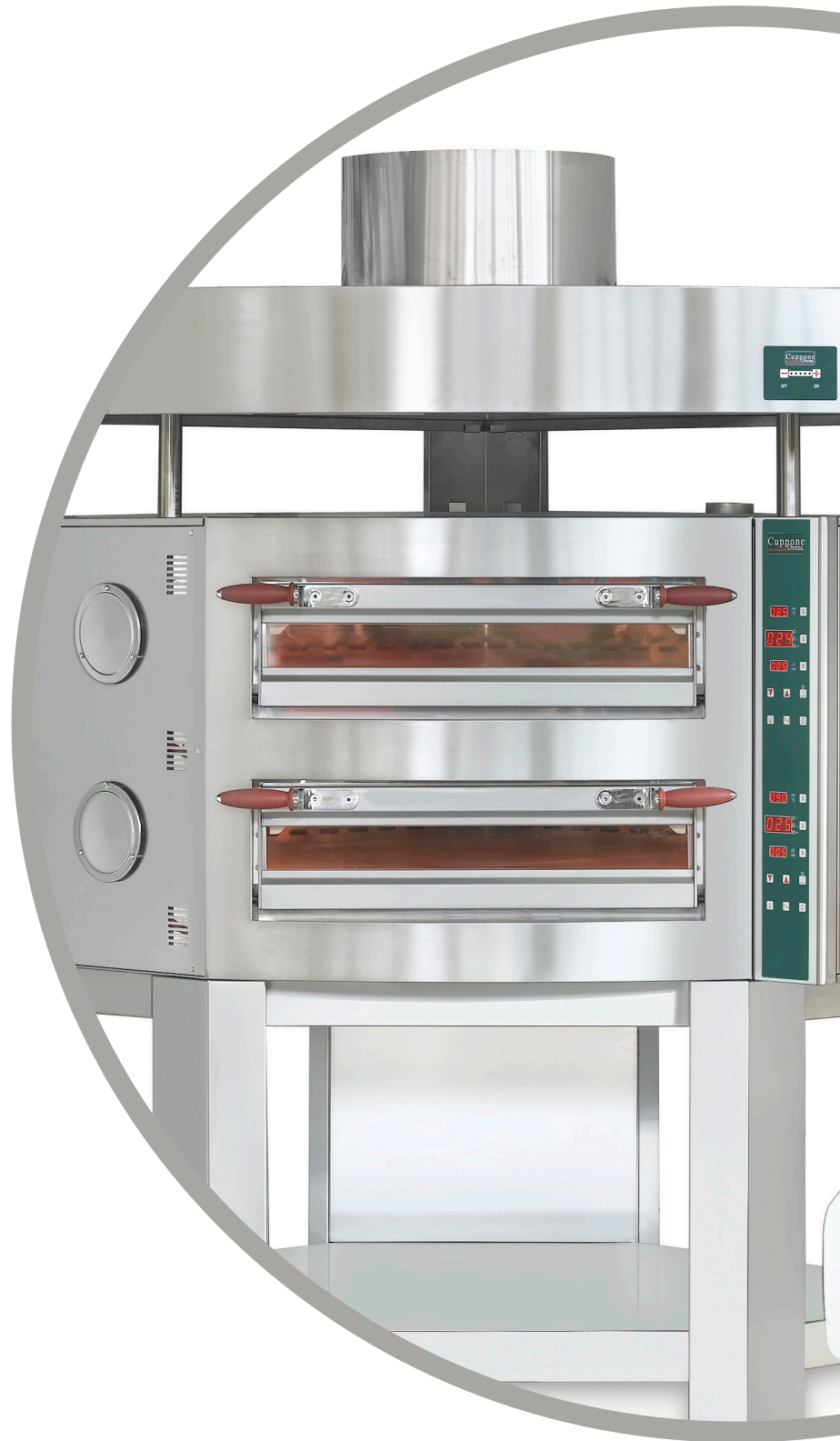

Parti di ricambio

Spare parts



Ersatzteile

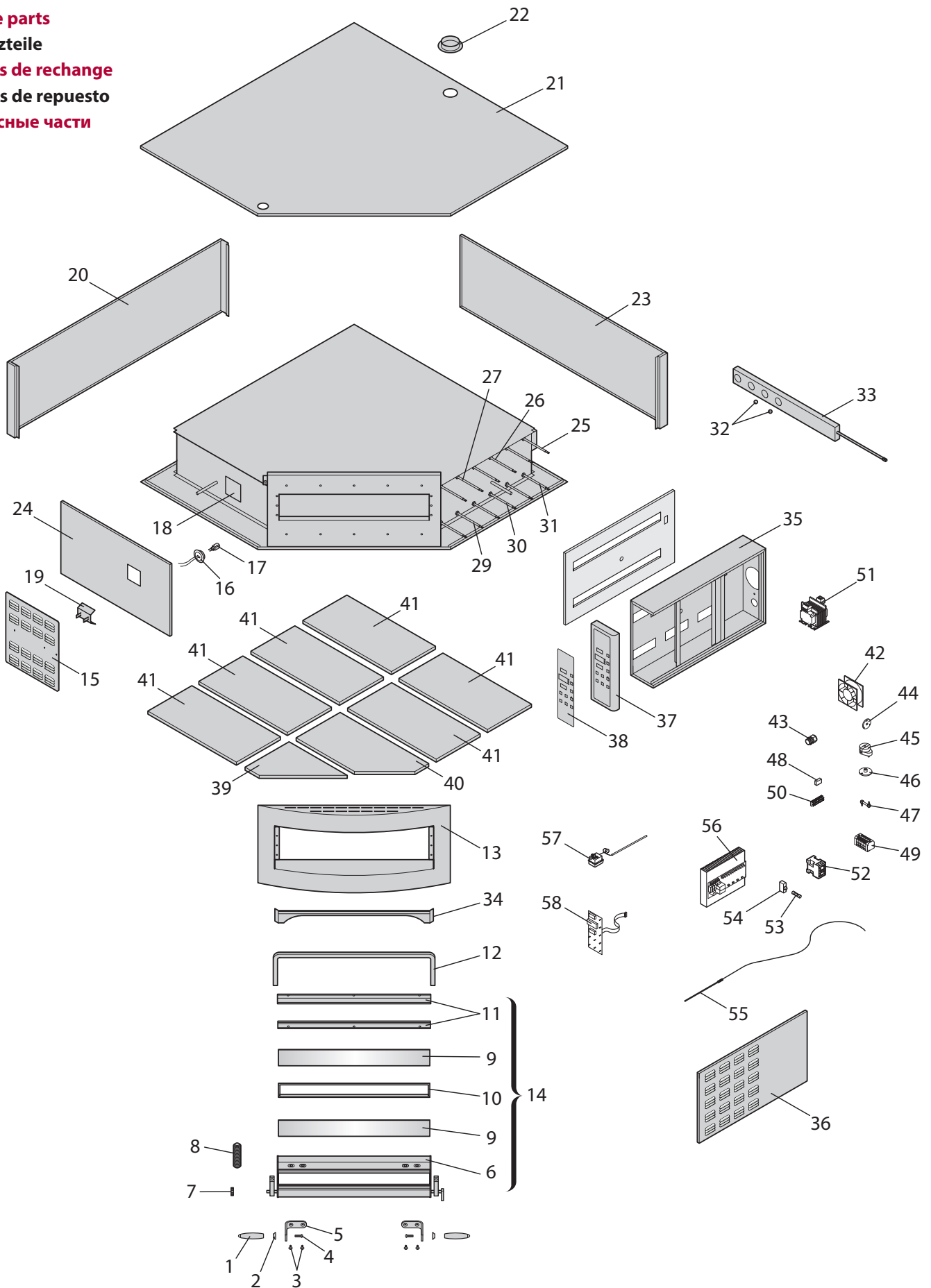

Pièces de rechange

Piezas de repuesto

Запасные части



Nr.	Codice Code	 Descrizione	 Description	 Beschreibung	Q.
1	91510000	Manopola con inserto rossa	Door handle	Türgriff	2
2	91510050	Rondella salvamani rossa	Hand protection washer	Handschutzgummi	2
3	91110015	Vite TPSE 6x20 inox	Screw TPSE 6x20	Schrauben TPSE 6x20	4
4	91110007	Vite TBE M12x30 inox	Screw TBE M12x30 inox	Schrauben TBE M12x30	2
5	92012065	Maniglia cromata porta EV	Chromium-plated handle	Halterung	2
6	92022060	Porta completa EV	Door EV	Tür	1
7	91410445	Pignone Z17-3/8	Pinion Z17-3/8	Ritzel Z17-3/8	1
8	92012245+ 92012550	Molla con catena	Spring and Chain	Feder und Kette	1
9	91610002	Vetro porta ceramico 713x93	Door glazing 713x93	Türglas 713x93	2
10	92033070	Distanziale vetro porta EV	Glass spacer EV	Distanzschiene Scheibe	1
11	92033080	Fermavetro porta EV	Door glass stopper EV	Profile Sichtfenster	2
12	92013500	Guarnizione porta EV	Fibreglass gasket	Glasfaserdichtung	1
13	92012080	Facciata completa EV835/1	Full front EV835/1	Vorderfront komplett EV835/1	1
14	92012060	Assieme porta	Door unit	Türensatz	1
15	92012305	Plafoniera EV835/1	Ceiling EV835 / 1	Decken-EV835 / 1	1
16	91310182	Portalamпада G4 12V	Lamp holder G4 12V	Lampenhalterung G4 12V	2
17	91310196	Lampada alogena G4, 20W, 12V	Halogen lamp G4, 20W, 12V	Halogenlampe G4, 20W, 12V	2
18	91610013	Vetro 180x85x9	Glass 180x85x9	Glas 180x85x9	1
19	92012310	Supporto lampade	Lamp support	Lampe Unterstützung	1
20	92012100	Fianco sinistro EV835/1	Left side EV835/1	Seitenpanel Links Karosserie EV835/1	1

Nr.	Code Код	 Description	 Descripción	 Описание	Q. К-во
1	91510000	Poignée porte	Tirador puerta	Ручка с вставкой красного цвета	2
2	91510050	Rondelle protège-doigts	Arandela salvamanos	Защитная шайба красного цвета	2
3	91110015	Vis TPSE 6x20	Tornillo TPSE 6x20	Винт TPSE 6x20 из нержавеющей стали	4
4	91110007	Vis TBE M12x30	Tornillo TBE M12x30	Винт TBE M12x30 из нержавеющей стали	2
5	92012065	Poignée chromé	Asa cromada	Хромированная ручка для дверцы EV	2
6	92022060	Porte complète	Puerta completa	Укомплектованная дверца EV	1
7	91410445	Pignon Z17-3/8	Piñón Z17-3/8	шестерня Z17-3/8	1
8	92012245+ 92012550	Ressort et chaîne	Muelle y cadena	Пружина дверцы и цепи	1
9	91610002	Vitre porte 713x93	Cristal de la puerta 713x93	Керамическое стекло 713x93	2
10	92033070	Entretoise verre EV	Distanziale vetro porta EV	Прокладка для стекла дверцы EV	1
11	92033080	Cale-vitre porte EV	Junquillo de puerta EV	Упор стекла дверцы EV	2
12	92013500	Joint en fibre de verre	Junta en fibra de vidrio	Прокладка дверцы EV	1
13	92012080	Façade complète EV835/1	Fachada completa EV835/1	Полный передняя панель EV835/1	1
14	92012060	Ensemble porte	Conjunto de puerta	Блок двери	1
15	92012305	Plafond EV835 / 1	Techo EV835 / 1	Потолочный EV835 / 1	1
16	91310182	Douille G4 12V	Portalampara G4 12V	Большой ламповый патрон G4 12V	2
17	91310196	Lampe halogène G4, 20W, 12V	Lámpara halógena G4, 20W, 12V	Галогенная лампа G4, 20Вт 12В	2
18	91610013	Verre 180x85x9	Vidrio 180x85x9	Стекло 180x85x9	1
19	92012310	Support de lampe	Soporte de lámpara	лампа поддержки	1
20	92012100	Flanc gauche EV835/1	Flanco izquierdo EV835/1	Левая боковина EV835/1	1

Parti di ricambio

Spare parts



Ersatzteile

Pièces de rechange

Piezas de repuesto

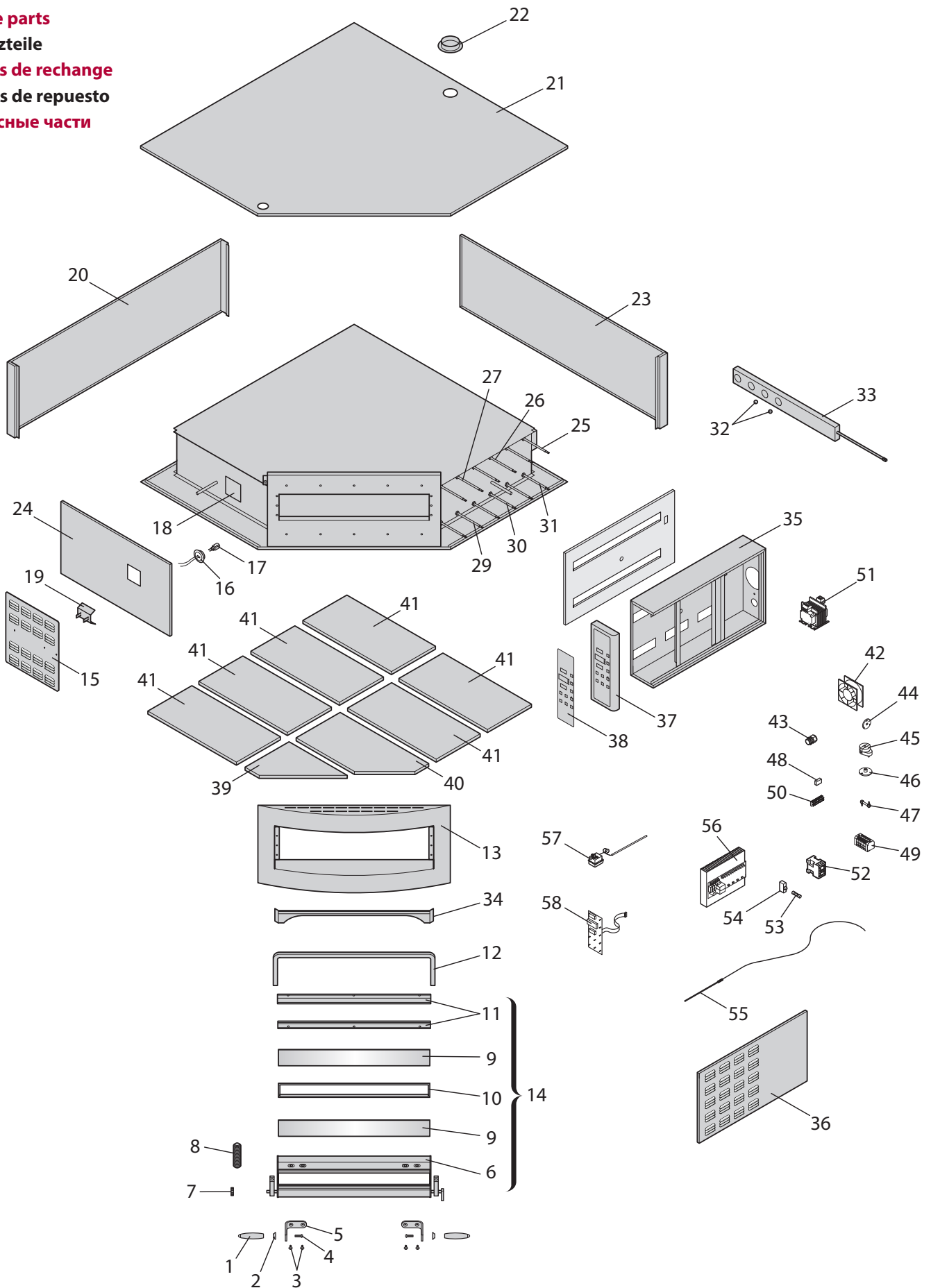
Запасные части



Nr.	Codice Code	 Descrizione	 Description	 Beschreibung	Q.
21	92012090	Coperchio EV	Cover	Deckel EV	1
22	92312030	Ghiera D.80	Ring D.80	Kaminring D.80	1
23	92012110	Fianco destro EV835/1	Right side EV835/1	Seitenpaneel Rechts Karosserie EV835/1	1
24	92012120	Pannello laterale sinistro EV835/1	Left lateral panel EV835/1	Seitenpaneel Links Karosserie EV835/1	1
25	91711072	Resistenza sup. post. EV 230V 2400W	Heating element EV 230V 2400W	Heizelement EV 230V 2400W	1
26	91711071	Resistenza sup. interm. EV 230V 2400W	Heating element EV 230V 2400W	Heizelement EV 230V 2400W	1
27	91711070	Resistenza sup. ant. EV 230V 2600W	Heating element EV 230V 2600W	Heizelement EV 230V 2600W	1
29	91711060	Resistenza inf. ant. EV 230V 1600W	Heating element EV 230V 1600W	Heizelement EV 230V 1600W	1
30	91711061	Resistenza inf. interm. EV 230V 1400W	Heating element EV 230V 1400W	Heizelement EV 230V 1400W	1
31	91711062	Resistenza inf. post. EV 230V 1400W	Heating element EV 230V 1400W	Heizelement EV 230V 1400W	1
32	91410030	Sfera camino EV	Ball	Sphäre	2
33	92012020	Scorrevole camino EV	Chimney slider EV	Schiebe Abluftkamin	1
34	92012010	Arco camera EV	Oven chamber arched profile EV	Hitzeschutzbogen Backkammer	1
35	92012150	Scatola comandi EV835/1	Control box EV835/1	Schaltkasten EV835/1	1
36	92012230	Pannello laterale destro EV835/1	Right lateral panel EV835/1	Seitenpaneel Rechts Karosserie EV835/1	1
37	92012220	Cruscotto EV835/1 elettronico	Electronic instrument panel EV835/1	Halteplatte Steuerung Elektronisch EV835/1	1
38	91611080	Frontale comandi EV835/1 elettronico	Electronic front control panel EV835/1	Frontpaneel Schaltelement Elektronisch EV835/1	1

Nr.	Code Код	 Description	 Descripción	 Описание	Q. К-во
21	92012090	Couvercle	Tapa	Крышка EV	1
22	92312030	Bague D.80	Abrazadera D.80	Зажимное кольцо Д.80	1
23	92012110	Flanc droit EV835/1	Flanco derecho EV835/1	Правая боковина EV835/1	1
24	92012120	Panneau gauche latéral EV835/1	Panel lateral izquierdo EV835/1	Левая боковая панель EV835/1	1
25	91711072	Résistance EV 230V 2400W	Resistencia EV 230V 2400W	Сопrotивление EV 230В 2400Вт	1
26	91711071	Résistance EV 230V 2400W	Resistencia EV 230V 2400W	Сопrotивление EV 230В 2400Вт	1
27	91711070	Résistance EV 230V 2600W	Resistencia EV 230V 2600W	Сопrotивление EV 230В 2600Вт	1
29	91711060	Résistance EV 230V 1600W	Resistencia EV 230V 1600W	Сопrotивление EV 230В 1600Вт	1
30	91711061	Résistance EV 230V 1400W	Resistencia EV 230V 1400W	Сопrotивление EV 230В 1400Вт	1
31	91711062	Résistance EV 230V 1400W	Resistencia EV 230V 1400W	Сопrotивление EV 230В 1400Вт	1
32	91410030	Sphère	Esfera	Шар дымовой трубы EV	2
33	92012020	Panneau coulissant cheminée EV	Corredera chimenea EV	Направляющая дымовой трубы EV	1
34	92012010	Profil en arc pour enceinte EV	Arco cámara EV	Дуга камеры EV	1
35	92012150	Boîte commandes EV835/1	Caja de mandos EV835/1	Коробка управления EV835/1	1
36	92012230	Panneau droit latéral EV835/1	Panel lateral derecho EV835/1	Правая боковая панель EV835/1	1
37	92012220	Tableau de bord électronique EV835/1	Cuadro electrónico EV835/1	Электронный пульт управления EV835/1	1
38	91611080	Panneau frontal électronique EV835/1	Delantera electrónica EV835/1	Электронная панель управления EV835/1	1

Parti di ricambio

Spare parts

Ersatzteile

Pièces de rechange

Piezas de repuesto

Запасные части

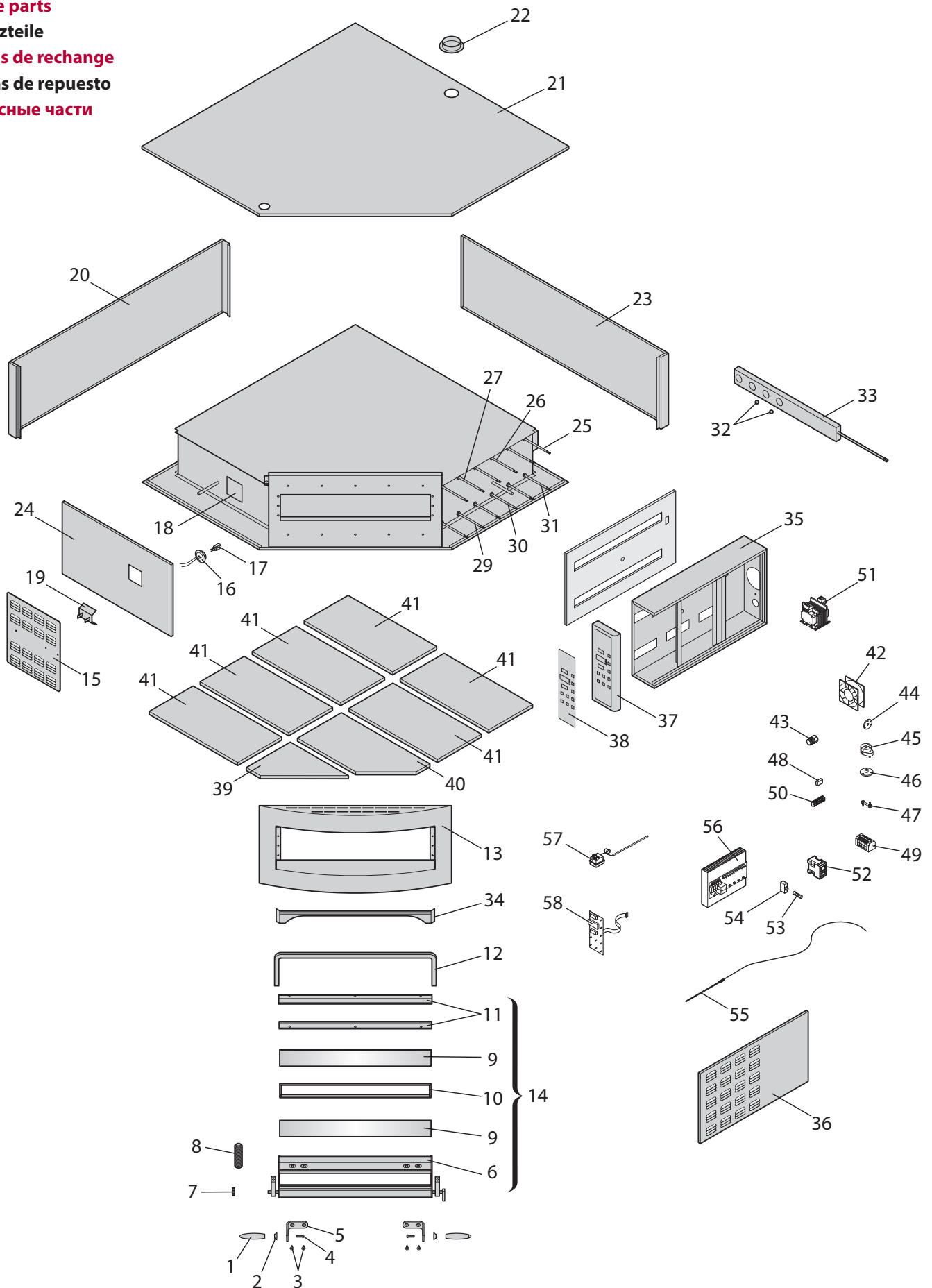

Nr.	Codice Code	 Descrizione	 Description	 Beschreibung	Q.
39	91610111	Mattone 49-294-343 anteriore sx	Stone 49-294-343	Stein 49-294-343	1
40	91610112	Mattone 343-294-588 anteriore dx	Stone 343-294-588	Stein 343-294-588	1
41	91610110	Mattone 588-294-588 posteriore	Stone 588-294-588	Stein 588-294-588	6
42	91310321	Ventola di raffreddamento	Impeller	Kühl-ventilator	1
43	91510224	Pressacavo PG 29	Cable clamp PG 29	Zug entlastung PG 29	1
44	92012200	Flangia PVC perno camino	PVC flange	Flansch PVC	1
45	91310530	Motore camino	Flue electric motor	Elektromotor für Abzug	1
46	92012190	Flangia motore camino	Flue motor flange	Flansch für Abzugelektromotor	1
47	91410040	Snodo camino	Flue articulated joint	Abzugsgelenk	1
48	91310540	Condensatore per motore camino	Condenser	Kondensator	1
49	91310231	Morsettiera G10/5 trifase	Three-phase terminal board G10/5	Klemmleiste dreiphasig G10/5	1
50	91310235	Morsettiera G5/12	Terminal board G5/12	Klemmleiste G5/12	1
51	91310356	Trasformatore 230/12V 50VA	Transformer 230/12V 50VA	Transformator 230/12V 50VA	1
52	91310136	Contattore (*)	Contacteur (*)	Schütz (*)	1
53	91310502	Fusibile 5X20F 1A	Fuse 5X20F 1A	Sicherung 5X20F 1A	1
54	91310512	Portafusibile 5x20	Fuse block 5x20	Sicherungshalterung 5x20	1
55	91310212	Sonda TCJ	Temperature sensor TCJ	Sonde TCJ	1
56	91310305	Scheda di potenza 16A	Power panel 16A	Leistungs Platine 16A	1
57	91310050	Termostato di sicurezza monofase	Single-phase safe thermostat	Überhitzungsschutz einphasing	1
58	91310256	Scheda di controllo	Control panel	Kohntroll Platine	1

Nr.	Code Код	 Description	 Descripción	 Описание	Q. К-во
39	91610111	Pierre 49-294-343	Piedra 49-294-343	Кирпич 49-294-343 передний лев.	1
40	91610112	Pierre 343-294-588	Piedra 343-294-588	Кирпич 343-294-588 передний прав.	1
41	91610110	Pierre 588-294-588	Piedra 588-294-588	Кирпич 588-294-588 задний	6
42	91310321	Ventilateur	Ventalle	Вентилятор	1
43	91510224	Serre-fils PG 29	Prensacable PG 29	Кабельный зажим PG 29	1
44	92012200	Bride en PVC	Brida de PVC	Фланец ПВХ штыря дымовой трубы	1
45	91310530	Moteur électrique cheminée	Motor eléctrico chimenea	Двигатель дымовой трубы	1
46	92012190	Bride moteur cheminée	Brida motor chimenea	Фланец двигателя дымовой трубы	1
47	91410040	Articulation cheminée	Articulación chimenea	Шарнир дымовой трубы	1
48	91310540	Condensateur	Condensator	Конденсатор для двигателя дымовой трубы	1
49	91310231	Bornier triphasé G10/5	Regleta de bornes trifásica G10/5	Трехфазная клеммная колодка G10/5	1
50	91310235	Bornier G5/12	Regleta de bornes G5/12	Клеммная колодка G5/12	1
51	91310356	Transformateur 230/12V 50VA	Transformador 230/12V 50VA	трансформатор 230/12V 50VA	1
52	91310136	Contacteur (*)	Contacteur (*)	Контактор (*)	1
53	91310502	Fusible 5X20F 1A	Fusible 5X20F 1A	Плавкий предохранитель 5X20F 1A	1
54	91310512	Porte-fusible 5x20	Portafusible 5x20	Плавкая вставка 5x20	1
55	91310212	Sonde TCJ	Sonda TCJ	Датчик TCJ	1
56	91310305	Carte de puissance 16A	Tarjeta de potencia 16A	Силовая плата 16A	1
57	91310050	Thermostat de sécurité monophasé	Termostato de seguridad monofásico	Однофазный защитный термостат	1
58	91310256	Carte de contrôle	Tarjeta de control	Контрольная плата	1

\* = 91310145 - EV 3 230V 50-60Hz  
 \* = 91310146 - EV 3 230V 60Hz USA

Parti di ricambio

Spare parts

Ersatzteile

Pièces de rechange

Piezas de repuesto

Запасные части

Сappa

Hood

Haube

Hotte

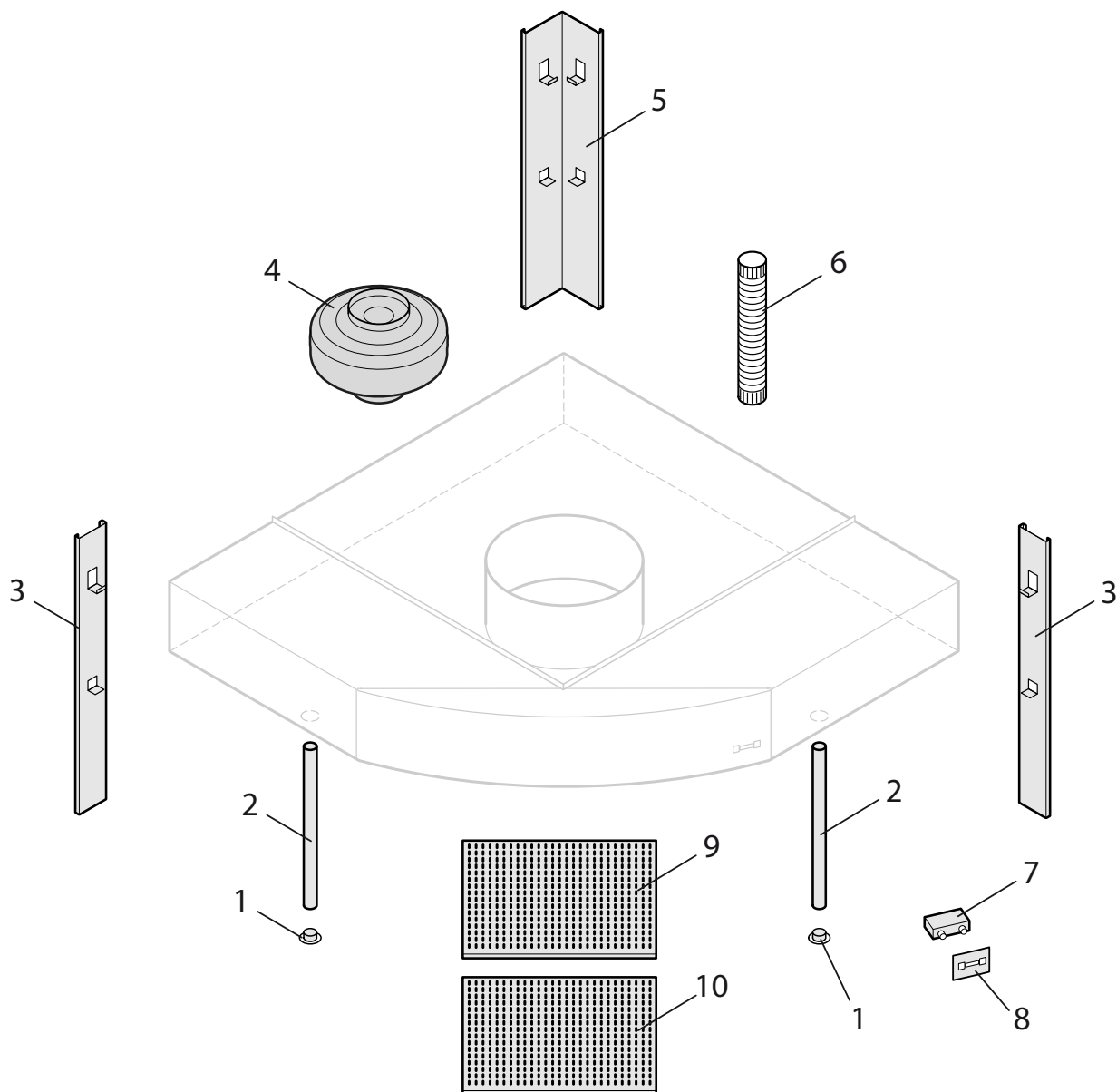

Самрана

Вытяжка





Parti di ricambio **Cappa**  
 Spare parts **Hood**  
 Ersatzteile **Haube**  
 Pièces de rechange **Hotte**  
 Piezas de repuesto **Campana**  
 Запасные части **Вытяжка**

Nr.	Codice Code	 Descrizione	 Description	 Beschreibung	Q.
1	92314145	Ghiera D. 30/45	Ring D. 30/45	Fassung D. 30/45	2
2	92314130	Sostegno anteriore cappa per EV835/1	Front hood support (EV835/1)	Vordere Haubenstütze (EV835/1)	2
2	92314135	Sostegno anteriore cappa per EV835/2	Front hood support (EV835/2)	Vordere Haubenstütze (EV835/2)	2
3	92314150	Sostegno laterale cappa per EV835/1	Lateral hood support (EV835/1)	Seitliche Haubenstütze (EV835/1)	1
3	92314155	Sostegno laterale cappa per EV835/2	Lateral hood support (EV835/2)	Seitliche Haubenstütze (EV835/2)	1
4	91310330	Aspiratore centrifugo VT 150	Aspirator VT 150	Absauganlage VT 150	1
5	92314160	Sostegno posteriore cappa per EV835/1	Rear hood support (EV835/1)	Hintere Haubenstütze (EV835/1)	1
5	92314165	Sostegno posteriore cappa per EV835/2	Rear hood support (EV835/2)	Hintere Haubenstütze (EV835/2)	1
6	91014000	Tubo flessibile D. 80 mt. 1,5	Flexible pipe D. 80 mt. 1,5	Biegsamer Ast D. 80 mt. 1,5	1
7	91310270	Scheda di controllo cappa	Control panel	Kohntroll Platine	1
8	91611300	Frontale comandi cappa CP neutra	Front panel CP	Frontpaneel CP	1
8	91611310	Frontale comandi cappa CP aspirata	Front panel CP for hood with motor	Frontpaneel CP für Haube mit Motor	1
9	92314115	Filtro interno cappa EV	Internal filter EV	Innenfilter EV	1
10	92314105	Filtro esterno cappa EV	External filter EV	Aussenfilter EV	1

Nr.	Code Код	 Description	 Descripción	 Описание	Q. К-во
1	92314145	Bague D. 30/45	Abrazadera D. 30/45	Зажимное кольцо Д. 30/45	2
2	92314130	Soutien antérieur (EV835/1)	Apoyo delantero (EV835/1)	Передняя опора вытяжки для EV835/1	2
2	92314135	Soutien antérieur (EV835/2)	Apoyo delantero (EV835/2)	Передняя опора вытяжки для EV835/2	2
3	92314150	Soutien latéral (EV835/1)	Apoyo lateral (EV835/1)	Боковая опора вытяжки для EV835/1	1
3	92314155	Soutien latéral (EV835/2)	Apoyo lateral (EV835/2)	Боковая опора вытяжки для EV835/2	1
4	91310330	Aspirateur VT 150	Aspirador VT 150	Центробежный aspirатор VT 150	1
5	92314160	Soutien postérieur (EV835/1)	Apoyo posterior (EV835/1)	Задняя опора вытяжки для EV835/1	1
5	92314165	Soutien postérieur (EV835/2)	Apoyo posterior (EV835/2)	Задняя опора вытяжки для EV835/2	1
6	91014000	Tube flexible D. 80 mt. 1,5	Tubo flexible D. 80 mt. 1,5	Шланг Д. 80 м 1,5	1
7	91310270	Carte de contrôle	Tarjeta de control	Контрольная плата вытяжки	1
8	91611300	Panneau frontal CP	Delantera CP	Командование фронта CP	1
8	91611310	Panneau frontal CP pour hotte avec moteur	Delantera CP para campana con motor	Командование фронта CP (капот потребление)	1
9	92314115	Filtre intérieur EV	Filtro interno EV	Внутренний фильтр вытяжки EV	1
10	92314105	Filtre extérieur EV	Filtro externo EV	Наружный фильтр вытяжки EV	1