

Raffaello (D)

Manuale installazione e uso
User and installation manual
Installations- und Gebrauchshandbuch



Parti di ricambio
Spare parts
Ersatzteile

RF435/1D - RF635/1D - RF635L/1D - RF935/1D

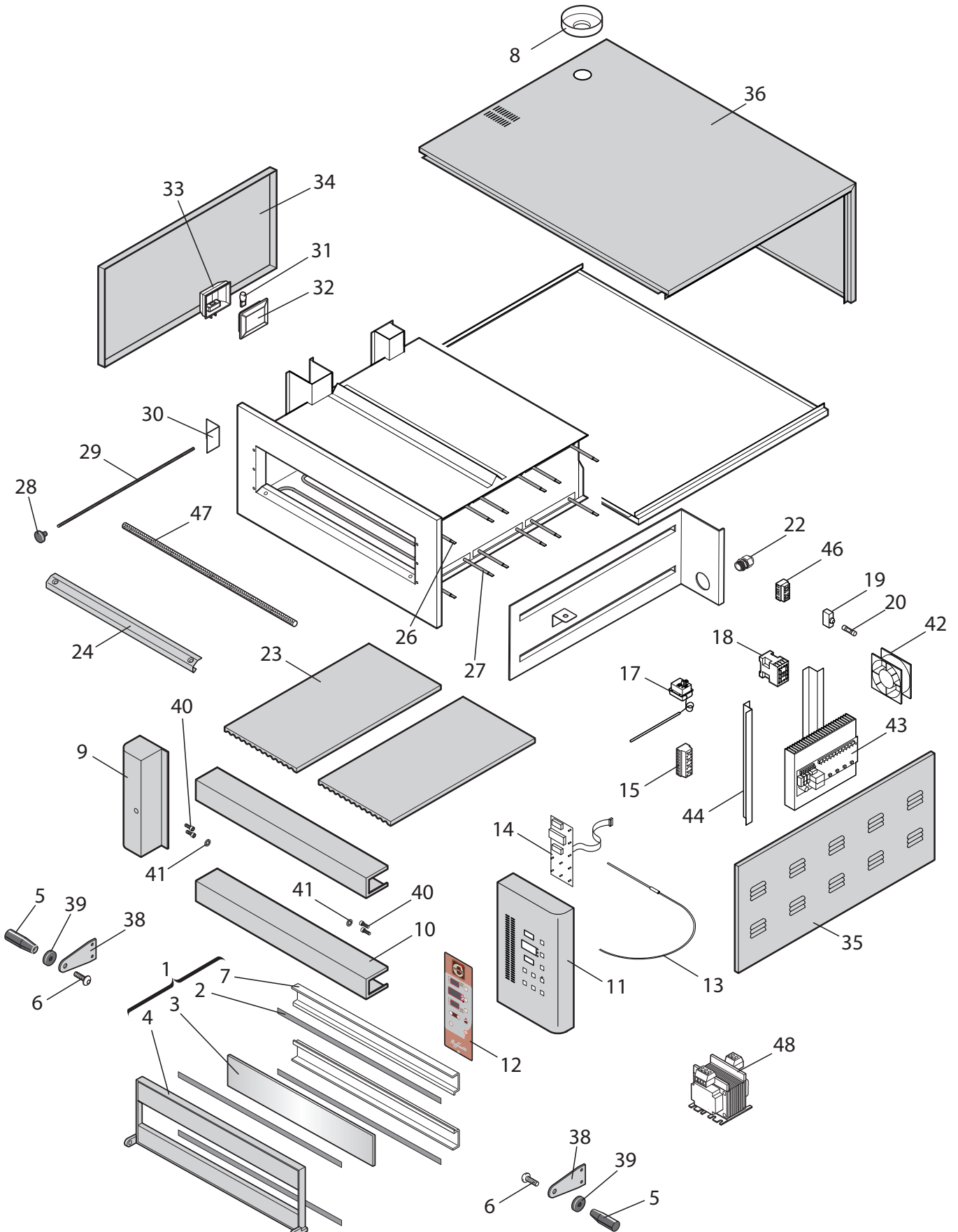

Parti di ricambio

Spare parts

Ersatzteile

RF435/1D - RF635/1D - RF635L/1D - RF935/1D

Nr.	Codice Code RF435/1D	Codice Code RF635/1D	Codice Code RF635L/1D	Codice Code RF935/1D	Descrizione	Description	Beschreibung	Q.
1	92810063	92810063	92710311	92710311	Assieme porta	Door unit	Türensatz	1
2	92820163	92820163	92720271	92720271	Guarnizione vetro	Glass gasket	Scheibendichtung	4
3	91610003	91610003	91610007	91610007	Vetro porta	Door glass	Türscheibe	1
4	92820133	92820133	92720231	92720231	Struttura porta	Door structure	Türrahmen	1
5	91510011	91510011	91510011	91510011	Manopola	Knob	Drehknopf	2
6	91110007	91110007	91110007	91110007	Vite inox TBE M12x30	St. steel TBE M12x30 screws	Schraube Edelstahl TBE M12x30	2
7	92820153	92820153	92720251	92720251	Profilo fermavetro	Glazing bead profile	Glashalteprofil	2
8	92810150	92810150	92810150	92810150	Ghiera camino	Flue ring nut	Schraubring Dampfablass	1
9	92710180	92710180	92710180	92710180	Colonna sx	Left column	Linke Säule	1
10	92710240	92710240	92710250	92710250	Banco	Counter	Bank	2
11	92710205	92710205	92710205	92710205	Colonna dx	Right column	Rechte Säule	1
12	91611640	91611640	91611640	91611640	Frontale comandi	Control panel front	Frontblende	1
13	91310212	91310212	91310212	91310212	Sonda TCJ	TCJ probe	Sonde TCJ	1
14	91310256	91310256	91310256	91310256	Scheda di controllo	Control board	Kontrollkarte	1
15	91310231	91310231	91310231	91310231	Morsettiera	Terminal board	Klemmenbrett	1
17	91310051	91310051	91310051	91310051	Termostato di sicurezza	Safety thermostat	Sicherheitsthermostat	1
18	91310136	91310136	91310136	91310136**	Contattore	Contactator	Schütz	1
19	91310511	91310511	91310511	91310511	Portafusibile	Fuse box	Sicherungshalterung	1
20	91310502	91310502	91310502	91310502	Fusibile	Fuse	Sicherung	1
22	91510223	91510223	91510223	91510223	Pressacavo	Cable gland	Zugentlastung	1
23	91610140	91610141	91610140	91610141	Mattone refrattario	Firebrick	Schamottestein	2/3*
24	92710050	92710050	92710051	92710051	Profilo fermapietre	Glazing bead profile	Steinhalteprofil	1
26	91711230	91711231	91711235	91711233	Resistenza superiore	Upper heating element	Oberer Heizwiderstand	3
27	91711210	91711211	91711212	91711213	Resistenza inferiore	Lower heating element	Unterer Heizwiderstand	3
28	91510046	91510046	91510046	91510046	Pomolo camino	Flue knob	Knauf Dampfablass	1
29	92720200	92720201	92720200	92720201	Asta camino	Flue pipe	Stange Dampfablass	1
30	92720210	92720210	92720210	92720210	Scorrevole camino	Sliding flue	Gleitelement Dampfablass	1
31	91310196	91310196	91310196	91310196	Lampada alogena	Halogen lamp	Halogenlampe	1
32	91610025	91610025	91610025	91610025	Vetro portalampada	Glass lamp holder	Leuchtenglas	1
33	91810185	91810185	91810185	91810185	Portalampada	Light socket	Glühbirnenhalterung	1
34	92710150	92710151	92710150	92710151	Pannello sx	Left panel	Paneel links	1
35	92710170	92710171	92710170	92710171	Pannello dx	Right panel	Paneel rechts	1
36	92710100	92710101	92710102+ 92710104	92710103+ 92710104	Involucro	Enclosure	Hülle	1
38	92810130	92810130	92810130	92810130	Maniglia inox	Stainless steel handle	Edelstahlgriff	2
39	91510060	91510060	91510060	91510060	Rondella salvamani	Flat (hand protection) washer	Handschutzgummi	2
40	91110011	91110011	91110011	91110011	Vite zincate TCE M8x16	Zinc-coated TCE M8x16 screws	Schraube verzinkt TCE M8x16	4
41	92810140	92810140	92810140	92810140	Rondella porta	Door washer	Unterlegscheibe Tür	2
42	91310320	91310320	91310320	91310320	Ventola	Fan	Gebälse	1
43	91310305	91310305	91310305	91310305	Scheda di potenza	Power board	Leistungsplatine	1
44	92710260	92710260	92710260	92710260	Sostegno scheda di potenza	Power board support	Halterung Leistungsplatine	1
46	91310236	91310236	91310236	91310236	Morsettiera G5/4	Terminal board G5/4	Klemmenbrett G5/4	1
47	92720282	92720282	92720283	92720283	Guarnizione porta	Fibreglass gasket	Glasfaserdichtung	1
48	91310356	91310356	91310356	91310356	Trasformatore 230/12V 50VA	Transformer 230/12V 50VA	Transformator 230/12V 50VA	1

* = 2 mattoni per i modelli RF435/1D e RF635/1D; - 3 mattoni per i modelli RF635L/1D e RF935/1D.

2 bricks for models RF435/1D and RF635/1D; - 3 bricks for models RF635L/1D and RF935/1D.

2 Stein beim Modell RF435/1D und RF635/1D; - 3 Stein beim Modell RF635L/1D und RF935/1D.

** = 91310145 - RF 935/930 AC 3 230 50/60 Hz