

P60E K
P80E K

P60E C
P80E C

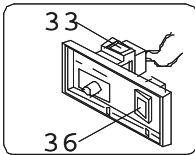

P60E B
P80E B

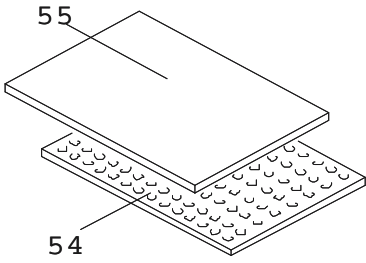
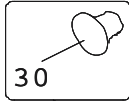
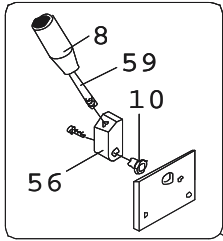
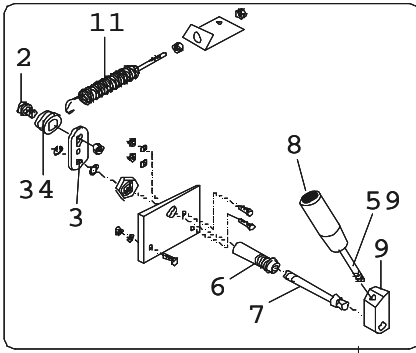
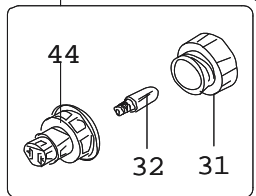
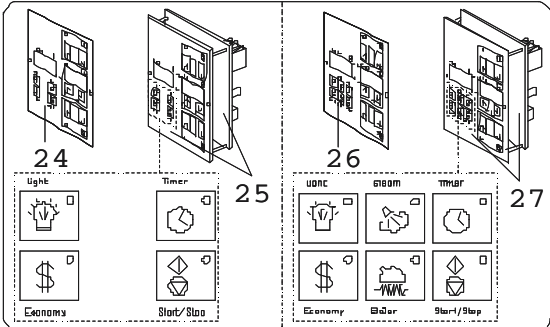
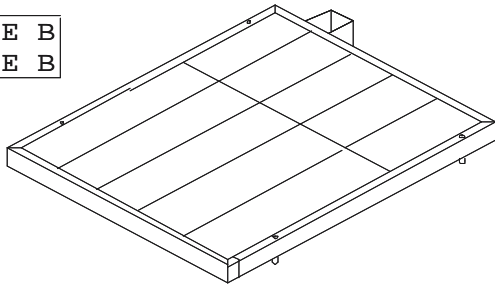

73340380 Revisiune 05 P60E-P80E K P60E-P80E C

su richiesta - sur demande - on demand

#	Tipo Type Type Type Tipo	Codice Code Code Code Codigo	DESCRIZIONE	Description Description Beschreibung Descripción	Descrizi INVOICE Descript Rechnun Descrip
2		72090000	PERNO PER ATTACCO MOLLA	Joint spring pin - Pivot attelage ressort - Bolzen für Federbefestigung - Eje enganche muelle	PERNO
3		72081810	BLOCCHETTO PER MOLLA E ASTA VALVOLA	Joint plate for valve spring and rod - Platine pour ressort et tige soupape - Fixierscheibe für Feder und Stange der Klappe - Palastro por muelle y varilla válvula	BLOCC VALVO
4	18/C	73700840	VETRO TEMPRATO MOLATO AI BORDI DA 697x135x5 (46800000)	Tempered glass with gasket - Verre trempé avec joint - Gehärtetesglas mit Dichtung - Vidrio templado con empaqueladura	VETRO 697x13
4	18/A-B	73700850	VETRO TEMPRATO MOLATO AI BORDI DA 385x135x5 (46800010)	Tempered glass with gasket - Verre trempé avec joint - Gehärtetesglas mit Dichtung - Vidrio templado con empaqueladura	VETRO 385x13
4	30/C	73700860	VETRO TEMPRATO MOLATO AI BORDI DA 697x163x5 (46800020)	Tempered glass with gasket - Verre trempé avec joint - Gehärtetesglas mit Dichtung - Vidrio templado con empaqueladura	VETRO 697x16
4	30/A-B	73700870	VETRO TEMPRATO MOLATO AI BORDI DA 385x163x5 (46800030)	Tempered glass with gasket - Verre trempé avec joint - Gehärtetesglas mit Dichtung - Vidrio templado con empaqueladura	VETRO 385x16
6		72005090	BOCCOLA PER CERNIERA SPORTELLINO SINISTRA	Bush for hinge left door - Douille pour charnière porte gauche - Büchse für Scharniere der linken Tür - Anillo por charnela puerta izquierda	BOCCO SINIST
7		72083970	PERNO PER CERNIERA SINISTRA	Pin for left hinge - Pivot pour charnière gauche - Bolzen für linke Scharniere - Eje por charnela izquierda	PERNO
8		73601170	IMPUGNATURA I.580/90 M12 TRASPARENTE (SP24875-EN122/0)	Transparent grip - Poignée transparente - Transparenthandgriff - Pomo transparente	IMPUG TRASP
9		71000030	CERNIERA SINISTRA TEFLONATA NERA (71000030)	Left hinge - Charnière gauche - Linke Scharniere - Charnela izquierda	CERNIA (71000
10		72005100	BOCCOLA PER CERNIERA SPORTELLINO DESTRA	Bush for hinge right door - Douille pour charnière porte droite - Büchse für Scharniere der rechten Tür - Anillo por charnela puerta derecha	BOCCO DESTR
11	18/C 30/A-B-C	72500660	MOLLA REGISTRABILE PER SPORTELLINO D.4 L=155	Door spring - Ressort porte - Tür feder - Resorte puerta	MOLLA D.4 L=

su richiesta - sur demande - on demand

#	Tipo Type Type Type Tipo	Codice Code Code Kode Codigo	DESCRIZIONE	Description Description Beschreibung Descripción	Descrizi INVOICE Descript Rechnun Descrip
11	18/A-B	72500670	MOLLA REGISTRABILE PER SPORTELLO D.2,8 L=127	Door spring - Ressort porte - Tür feder - Resorte puerta	MOLLA D.2,8 L
20	A-B	769008B0	A. SMALTATO FRONTALE CAPPABLU L=969 (46602320)	Hood frontal-blue - Fronton hotte-blue - Haubenfront-Blau - Frontal campana-azul	A. SMA L=969
20	A-B	769008M0	A. SMALTATO FRONTALE CAPPAMATTONE L=969 (46602320)	Hood frontal-brick brown - Fronton hotte-marron brique - Haubenfront-Ziegelsteinrot - Frontal campana-marrón	A. SMA MATTO
20	A-B	769008N0	A. SMALTATO FRONTALE CAPPANERO L=969 (46602320)	Hood frontal-black - Fronton hotte-noir - Haubenfront-Schwarz - Frontal campana-negro	A. SMA L=969
20	C	769009B0	A. SMALTATO FRONTALE CAPPABLU L=1169 (46602330)	Hood frontal-blue - Fronton hotte-blue - Haubenfront-Blau - Frontal campana-azul	A. SMA L=1169
20	C	769009M0	A. SMALTATO FRONTALE CAPPAMATTONE L=1169 (46602330)	Hood frontal-brick brown - Fronton hotte-marron brique - Haubenfront-Ziegelsteinrot - Frontal campana-marrón	A. SMA MATTO
20	C	769009N0	A. SMALTATO FRONTALE CAPPANERO L=1169 (46602330)	Hood frontal-black - Fronton hotte-noir - Haubenfront-Schwarz - Frontal campana-negro	A. SMA L=1169
24		76700600	ETICHETTA POLYES. CON COD. 76800600 C.L.(CARBON LOOK)	Label control panel + timer - Etiquette-panneau de control + timer - Etikett-Schalltafel + timer - Tarjeta-panel de mando + timer	ETICHE C.L.(CA
25		76800600	CENTRALINA DIGIT. MOD. EL. PIZ-PAS.+ TIMER C.L.(CARBON LOOK)	Electronic control panel timer - Panneau de control électronique blue - Elektronische Schalltafel Timer - Panel de mando electronico timer	CENTR TIMER
26	VP	76700700	ETICHETTA POLYES. CON COD. 76800700 C.L.(CARBON LOOK)	Label control panel + timer + hum. - Etiquette-panneau de control + timer + hum. - Etikett-Schalltafel + Timer + Bef. - Tarjeta-panel de mando + timer + hum.	ETICHE C.L.(CA
27	VP	76800700	CENTRALINA DIGIT. MOD. EL. PAS.+TIMER+VAP. C.L.(CARBON LOOK)	Electronic control panel timer + hum. - Panneau de control électronique timer + hum. - Elektronische Schalltafel Timer + Bef. - Panel de mando electronico timer + hum.	CENTR PAS.+T
28	18/A-B	68001810	A. SPORTELLO MHC/18/AB PC/GAS/AB	Door without handle and grip - Porte sans levier et poignée - Tür ohne Hebel und Griff - Puerta sin palanca y pomo	A. SPO

su richiesta - sur demande - on demand

#	Tipo Type Type Type Tipo	Codice Code Code Kode Codigo	DESCRIZIONE	Description Description Beschreibung Descripción	Descrizi INVOICE Descript Rechnun Descrip
28	18/C	68001820	A. SPORTELLLO MHC/18/C PC/GAS/C	Door without handle and grip - Porte sans levier et poignée - Tür ohne Hebel und Griff - Puerta sin palanca y pomo	A. SPO
28	30/A-B	68001830	A. SPORTELLLO MHC/30/AB	Door without handle and grip - Porte sans levier et poignée - Tür ohne Hebel und Griff - Puerta sin palanca y pomo	A. SPO
28	30/C	68001840	A. SPORTELLLO MHC/30/C	Door without handle and grip - Porte sans levier et poignée - Tür ohne Hebel und Griff - Puerta sin palanca y pomo	A. SPO
29	18/A PIZ	509001N0	PANNELLO LATERALE DX. SN. NERO	Black right and left side panel - Panneau latéral droit et gauche noir - Schwarzer rechter und linker seidl. Paneel - Panel lateral dorecho y izquierdo negro	PANNE
29	18/A PAS	509001S0	PANNELLO LATERALE DX. SN. SIMIL INOX	Similar inox right and left side panel - Panneau latéral droit et gauche semblable inox - Stahllähnlich rechter und linker seidl. Paneel - Panel lateral dorecho y izquierdo similar inox	PANNE
29	18/B-C PIZ	509002N0	PANNELLO LATERALE DX. SN. NERO	Black right and left side panel - Panneau latéral droit et gauche noir - Schwarzer rechter und linker seidl. Paneel - Panel lateral dorecho y izquierdo negro	PANNE
29	18/B-C PAS	509002S0	PANNELLO LATERALE DX. SN. CREMA	creme right and left side panel - Panneau latéral droit et gauche creme - Cremegelb rechter und linker seidl. Paneel - Panel lateral dorecho y izquierdo crema	PANNE
29	30/A PIZ	509003N0	PANNELLO LATERALE DX. SN. NERO	Black right and left side panel - Panneau latéral droit et gauche noir - Schwarzer rechter und linker seidl. Paneel - Panel lateral dorecho y izquierdo negro	PANNE
29	30/A PAS	509003S0	PANNELLO LATERALE DX. SN. SIMIL INOX	Similar inox right and left side panel - Panneau latéral droit et gauche semblable inox - Stahllähnlich rechter und linker seidl. Paneel - Panel lateral dorecho y izquierdo similar inox	PANNE
29	30/B-C PIZ	509004N0	PANNELLO LATERALE DX. SN. NERO	Black right and left side panel - Panneau latéral droit et gauche noir - Schwarzer rechter und linker seidl. Paneel - Panel lateral dorecho y izquierdo negro	PANNE
29	30/B-C PAS	509004S0	PANNELLO LATERALE DX. SN. SIMIL INOX	Similar inox right and left side panel - Panneau latéral droit et gauche semblable inox - Stahllähnlich rechter und linker seidl. Paneel - Panel lateral dorecho y izquierdo similar inox	PANNE
30		73600760	POMELLO P.131/45 M10 (ART.46501) (NERO)	Black knob - Pommeau noir - Schwarzer Knauf - Pomo negro	POMEL (NERO)

su richiesta - sur demande - on demand

#	Tipo Type Type Type Tipo	Codice Code Code Kode Codigo	DESCRIZIONE	Description Description Beschreibung Descripción	Descrizi INVOIC Descript Rechnu Descrip
31		73700690	CALOTTA IN VETRO FILETTATA D.74	Glass calotte - Calotte en verre - Glasschutzhaube - Tapa di vidrio	CALOT
32		74420260	LAMPADINA V220 25W E14	Bulb W25 V230 - Ampoule W25 V230 - W25 V230 Lampe - Lámpara W25 V230	LAMP
33		74200370	TERMOSTATO SICUR.RIARMO MANUALE 500^ 55.19584.010	Safety thermostat (reset) - Thermostat de sécurité (réenclenchement) - Sicherheitsthermostat (Reset) - Termostato de seguridad (rearmer)	TERMO 500^ 5
34		72090010	BOCCOLA PER ATTACCO MOLLA	Bush for joint spring - Douille pour attelage ressort - Büchse für Federsbefestigung - Anillo engancho muelle	BOCCO
36		74500760	INTER.BIP.LUMIN. BLU C/NERA 40100I1516/A83	blue switch 0-1 - Interrupteur blue 0-1 - Blau Schalter 0-1 - Interruptor azul 0-1	INTER. 40100I
37	V230	74610020	MORSETTI 8WA1 205 35mmq	Terminals - Bornes - Klammer - Bornes	MORSE
38	V230	74610190	MORSETTO DA 10mmq PER BASE OMEGA GIALLO-VERDE	Terminals - Bornes - Klammer - Bornes	MORSE GIALL
41	A	74420350	RESISTENZA CORAZZATA V.110 W.400 PLATEA MODULO A	Armored heating element-bottom - Résistance blindée-sole - Gepanzerte Heinzelement-boden - Resistencia blindada-techo	RESIS PLATE
41	B	74420370	RESISTENZA CORAZZATA V.110 W.500 PLATEA MODULO B	Armored heating element-bottom - Résistance blindée-sole - Gepanzerte Heinzelement-boden - Resistencia blindada-techo	RESIS PLATE
41	C	74420410	RESISTENZA CORAZZATA V.110 W.560 PLATEA MODULO C	Armored heating element-bottom - Résistance blindée-sole - Gepanzerte Heinzelement-boden - Resistencia blindada-techo	RESIS PLATE
43		74110200	TRASFORMATORE 1123593 10VA 12V 230V CLASSE 2 UL	Tridonic transformer - Transformateur tridonic - Tridonic Transformator - Transformador tridonic	TRASF CLASS
44		74700070	PORTALAMPADA SENZA CALOTTA S.751 A.704 202	Lamp holder - Douille - Lampenfassung - Portalámparas	PORTA A.704 2

#	Tipo Type Type Type Tipo	Codice Code Code Kode Codigo	DESCRIZIONE	Description Description Beschreibung Descripción	Descrizi INVOICE Descript Rechnun Descrip
45		66080820	A. TERMOCOPPIA 100	Thermocouple - Thémocouple - Thermoelement - Termopar	A. TER
48	V400	74550230	CONTATTORE 3RT10 16-1AP01 230V 50/60Hz 20A	Contactor - Contacteur - Kontaktgeber - Contactor	CONTA 50/60H
48	V230	74550500	CONTATTORE 3RT10 24-1AP00 230V 50/60 Hz 35A	Contactor - Contacteur - Kontaktgeber - Contactor	CONTA Hz 35A
50		74600080	SOPPRESS. RC INNESTO FILO OHM.100 mF.0,1 VAC.250 VCC.630	Suppressor - Suppresseur - Entstörer - Supresor	SOPPR mF.0,1
51	V400	74610340	MORSETTIERA A 6 POLI FV122	Terminals board - Platine des bornes - Klemmkaste - Bornera	MORSE
52	A PAST	74420340	RESISTENZA CORAZZATA V.110 W.600 CIELO MODULO A	Armored heating element-top - Résistance blindée-voûte - Gepanzerte Heinzelement-decke - Resistencia blindada-suelo	RESIS CIELO
52	A PAST	74420360	RESISTENZA CORAZZATA V.110 W.750 CIELO MODULO B	Armored heating element-top - Résistance blindée-voûte - Gepanzerte Heinzelement-decke - Resistencia blindada-suelo	RESIS CIELO
52	C PAS	74420400	RESISTENZA CORAZZATA V.110 W.850 CIELO MODULO C	Armored heating element-top - Résistance blindée-voûte - Gepanzerte Heinzelement-decke - Resistencia blindada-suelo	RESIS CIELO
52	A PIZZA	74420560	RESISTENZA CORAZZATA V.115 W.910 CIELO PIZ.MOD.A	Armored heating element-top - Résistance blindée-voûte - Gepanzerte Heinzelement-decke - Resistencia blindada-suelo	RESIS CIELO
52	B PIZZA	74420570	RESISTENZA CORAZZATA V.115 W.1092 CIELO PIZ.MOD.B	Armored heating element-top - Résistance blindée-voûte - Gepanzerte Heinzelement-decke - Resistencia blindada-suelo	RESIS CIELO
52	C PIZZA	74420590	RESISTENZA CORAZZATA V.115 W.1275 CIEL.PIZ.MOD.C	Armored heating element-top - Résistance blindée-voûte - Gepanzerte Heinzelement-decke - Resistencia blindada-suelo	RESIS CIEL.P
54	A-B	50645790	PIANALE DI COTTURA MHC/18- 30/A	Embossed sheet steel deck - Sole de cuisson en tôle alluminée - Backboden aus Noppenstahlblech - Placa de cocción de plancha almohadillada	PIANAL

su richiesta - sur demande - on demand

#	Tipo Type Type Type Tipo	Codice Code Code Kode Codigo	DESCRIZIONE	Description Description Beschreibung Descripción	Descrizi INVOICE Descript Rechnun Descrip
54	C	50645800	PIANALE DI COTTURA MHC/18-30/C	Embossed sheet steel deck - Sole de cuisson en tôle alluminée - Backboden aus Noppenstahlblech - Placa de cocción de plancha almohadillada	PIANALE
55	C	76001720	TAVELLA IN REFRATTARIO SABBIAIA 805X415X15	Refractory brick flat tile - Brique plate en réfractaire - Schamottplatte - Ladrillo refractario	TAVELLA 805X415
55	A-B	76001730	TAVELLA IN REFRATTARIO SABBIAIA 605X415X15	Refractory brick flat tile - Brique plate en réfractaire - Schamottplatte - Ladrillo refractario	TAVELLA 605X415
56		71000080	CERNIERA TEFLONATA NERA (71000310)	Hinge - Charnière - Scharniere - Charnela	CERNIERA
57		74015430	ELETTOVENT. DCF-RE 180/4 W=102 CON ATTACCO ASP. (500MC)	Fan - Ventilateur - Lüfterrad - Ventilador	ELETTOVENT. ATTACCO
58		74550850	INTERR. BIPOL. LUMIN.ARANCIO 30x22 SER. 0-1 MD 0401/L/G	Fan - Ventilateur - Lüfterrad - Ventilador	INTERR. SER. 0
59	18/A-B-C	72008290	LEVA ROTAZIONE SPORTELLO ZINC. NERA (TIPO 18)	Door lever - Levier porte - Türhebel - Palanca puerta	LEVA ROTAZIONE NERA (TIPO 18)
59	30/A-B-C	72008450	LEVA ROTAZIONE SPORTELLO ZINC. NERA (TIPO 30)	Door lever - Levier porte - Türhebel - Palanca puerta	LEVA ROTAZIONE NERA (TIPO 30)