

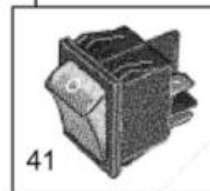

- 
- 0 Parti Elettriche
  - 1 Parti Carrozzeria

Ricambi parti elettriche - Spare parts key - Rechange parties  
électriques - Elektrische Ersatzteile - Repuestos piezas eléctricas

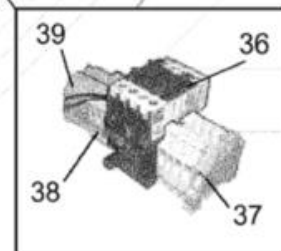

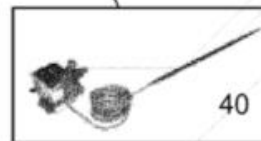
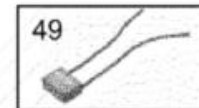
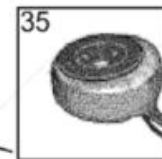
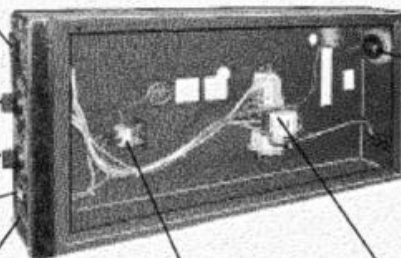
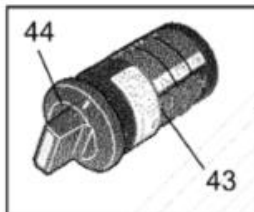
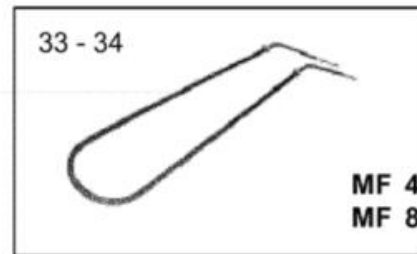
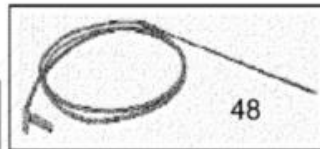
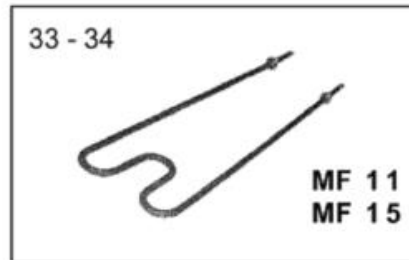
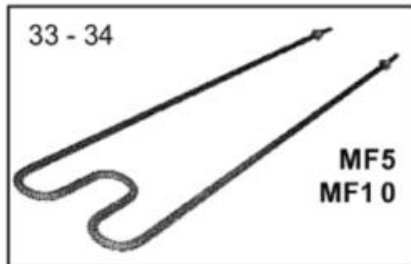

Pos	Codice	Descrizione	notes	
0033	EE150	RESIST.W.1900 V.400 33H+99M-C.		
0033	EE248	RESISTENZA W.2000 V.230 F99M+E		
0034	EE114	RESIS.W1600 V.400 F.33M-99M PL		
0034	EE248	RESISTENZA W.2000 V.230 F99M+E		
0035	EH045	TRASF.TOROID.T50W 230/12+MORS.		
0036	EN082	TELERUTTORE BF.9.10.230.50.60		
0037	EP038	Morsetto terra		
0038	EP008	Morsetto a vite		
0039	EP002	Morsetto a vite		
0040	ED023	TERMOST.DI SICURA+RIP.MANUALE		
0041	EF004	Interruttore bipolare		
0042	EF023	DEVIAT.UNIP.NERO 16A LAMP.INT.		
0043	EH009	COMMUTAT.TRIPOLARE 16A.FORNI		
0044	AC062	MANOPOLA COMMUTAT.EH009+EH030		
0045	ED077	TERM.IC 912 TCJ 230V.PR.SP.OEM		
0048	ED065	TERMOC"J"D.2X250+CAVO 1,5MT		
0049	EN073	Antidisturbo		

Ricambi carrozzeria - Body spare parts - Rechange carrosserie - Mantel-Ersatzteile - Repuestos estructura

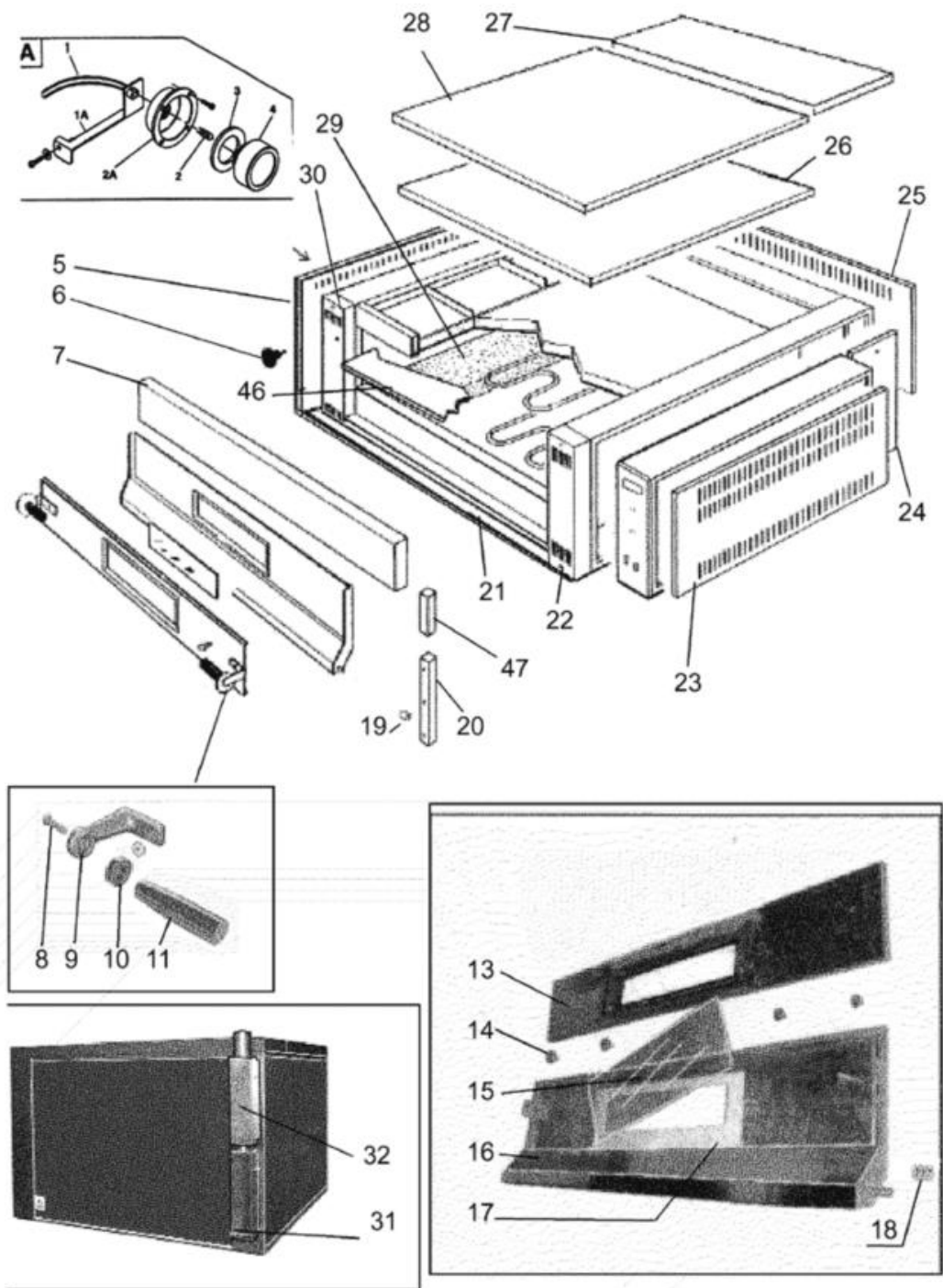



Pos	Codice	Descrizione	notes	
0001	EL056	COMPL.PORTALAMPADA FORNI		
0001A	HAT64	FISSAGGIO LAMPADA F.S.2000		
0002	EL062	MICROLAMP.ALOG.GY6.35 12V 35 W		
0002A	QAT22	PARABOLA LUCE IN ALLUM.FORNI		
0003	AL266	GUARN.LAMP.DI.32,5 D.E.55 SP12		
0004	AL201	VETRO LAMPADA F.S2000+PJ+MF+DS		
0005	DRB07	FIANCO SX MF8+10+11+15 NERO		
0006	AC065	POMELLO CAMINO FORNO PL/50 M10		
0007	H3SB5	CAPPA		
0008	MB088	VITE TE M8X35 INOX UNI5739		
0009	HDTV3	PIATTO P/MANIGLIA IN ALLUMINIO		
0010	AC071	RONDELLA D.36 H.12 FORO 8,5		
0011	AC066	MANOP.P.FORNO TP.N.MC/29X115		
0013	HSLP2	COPRIP.SUP.ST 11/15/96/99/109		
0014	HST03	VOLANT.ST.FIS.COP.D19 CR.HAT43		
0015	AL276	VETRO P.CERAM.MM.131X410 SP.4		
0016	HSL01	COPRIPORTA STAND.INF.96-99-109		
0017	AL278	GUARNIZIONE VETRO 430X155 MM		
0018	MD049	MOLLA F.2.5-16 CM.48 FORNO		
0019	HKT01	BOCCOLA PERNO PORTA D.14X10X22		
0020	H3KV4	PIANTONE INFERIORE		
0021	H3SM4	SCIVOLO INFERIORE ST MF/15+11		
0022	H3SB2	PANNELLO dx		
0023	DRB08	FIANCO DX MF8CL+MF10/11+8DS N.		
0024	H5B77	CHIUS.F.CO DX-SX MF10 (HVB77)		
0025	H3B09	SCHIENALE FORNO MF15-11 NERO		
0026	000000	CODICE NON ORDINABILE		
0027	HVM33	C.COP.P/MULT.F33/34 V.N.(HCM33		
0028	HV320	COPERCHIO		
0029	AL179	PIETRA REFR.913X455X19 F.99		
0030	H3SB3	PANNELLO sx		
0031	WCE37	TAPPO INF.CAM.EST.S.2000 ACC.		
0032	WCE40	COMPL.CAM.ESTERNO S.2000 ACC.		
0046	H3SB4	Scivolo divisorio		
0047	H3KV3	PIANTONE SUPERIORE		